

INSTALLATION / USER MANUAL

AIR CONDITIONER

Please read this manual carefully before operating your set and retain it for future reference.

AC Ez Touch
PACEZA000, CACEZA000



P/NO : MFL69517401

www.lg.com

TABLE OF CONTENTS

3 TIPS FOR SAVING ENERGY

4 IMPORTANT SAFETY INSTRUCTIONS

7 COMPONENTS

8 PRODUCT SPECIFICATION

9 NAME OF EACH PART

9 Name

10 HOW TO USE

10 Menu composition

11 Home screen composition and function

12 Top bar detail screen

13 Status screen

14 Menu screen

15 Control screen

18 Information input method

19 Air conditioner control

24 Ventilation(ERV and ERV DX) control

26 Heating control

28 Schedule view

29 Add schedule

31 Edit schedule

33 Delete schedule

34 View report

36 Emergency stop

37 Setting

38 Operation setting

41 Group setting

44 System setting

45 System setting (General setting)

48 System setting (Advanced setting)

53 Screen setting

56 Installer setting

62 PC access

63 Installation and setting

64 Installation environment check and setting up the equipment address

66 Central control address of the indoor unit set-up

72 Check list before calling for service

72 Guide to open source software

TIPS FOR SAVING ENERGY

Here are some tips that will help you minimize the power consumption when you use the air conditioner. You can use your air conditioner more efficiently by referring to the instructions below.

- Do not cool excessively indoors. This may be harmful for your health and may consume more electricity.
- Block sunlight with blinds or curtains while you are operating the air conditioner.
- Keep doors or windows closed tightly while you are operating the air conditioner.
- Adjust the direction of the air flow vertically or horizontally to circulate indoor air.
- Speed up the fan to cool or warm indoor air quickly, in a short period of time.
- Open windows regularly for ventilation as the indoor air quality may deteriorate if the air conditioner is used for many hours.
- Clean the air filter once every 2 weeks. Dust and impurities collected in the air filter may block the air flow or weaken the cooling / dehumidifying functions.

For your records

Staple your receipt to this page in case you need it to prove the date of purchase or for warranty purposes. Write the model number and the serial number here.

Model name : _____

Serial number : _____

You can find them on a label on the side of each unit.

Dealer's name : _____

Date of purchase : _____

IMPORTANT SAFETY INSTRUCTIONS

READ ALL INSTRUCTIONS BEFORE USING THE APPLIANCE.

- The installation work requires a specialized technology, so it shall be installed through the service center or an installation specialized store acknowledged by LG.
- If the installation work is done without an installation license, the installer will be responsible for all problems related to the installation, and in such case, LG will not provide the free of charge A/S.
- The following safety related cautions are to prevent the unexpected risk or damage in advance.

WARNING

If the instructions are not followed, it may cause death or severe injury of the user.

CAUTION

If the instructions are not followed, it may cause injury or property damage of the user.

 These are the symbols to alert the matters and operations that may have risks. Please carefully read them and follow the instructions to avoid the risk.

 This is a symbol that indicates the action to avoid for reducing risk.

NOTE

System air conditioner is not to be moved. If it has to be moved inevitably, make sure to contact the system air conditioner store with LG Electronics system air conditioner installation license.

WARNING

Installation

- When you re-install this product, please contact your Supplier or Installation Company to carry out the work. If someone inexperienced installs the product, it may result in fire, electric shock, explosion, injury, or failure of the product.
- Ensure there is no damage the power cable. It may cause fire or electric shock.
- When you perform any electrical work, please contact the Supplier or Installation Company. If an inexperienced person performs the disassembly or repair, it may cause fire or electric shock.
- Install the product that can avoid rain water. If water enters into the product, it may cause product failure.
- Do not install the product at a place with a lot of moisture. If moisture enters the product, it may cause product failure.
- Make sure to contact the Supplier or Installation Company for the product installation. If someone inexperienced installs the product, it may result in fire, electric shock, explosion, injury, or failure of the product.
- Please ensure an electrical engineer perform the electric work based on the installation manual and the designated circuit diagram. If incorrect wiring is used, or inexperienced engineer performs the electric work, it may cause fire or electric shock.
- Do not place the product near an electric fire. It may cause fire.
- Avoid installing this controller in an area with sensitive electronic equipment. It may cause electrical interference with sensitive electronics.

- Install the product fixed firmly. If the product is not securely fixed, it may fall and become damaged.
- Correctly install the product after fully studying the provided manual. It may cause fire or electric shock.
- During the wiring, do not use non-standard cable and do not force or extend the cable. It may cause fire or electric shock.
- During the wiring of the power cable and communication cable, firmly fix the cable. If the cable is loose, it may cause fire or electric shock.
- Do not connect the power cable to a communication terminal. It may cause fire or electric shock or it may cause the product failure.
- Do not install the product in a place where combustible gas may leak. It may cause fire, electric shock, explosion, injury of the user, or product failure.
- Install the product without tension on the cable. If the tension is applied on the cable, the cable may be broken, or it may cause fire by the heat generation.
- Do not use damaged plugs or connectors. It may cause electric shock or product failure.
* If it is a model using a plug.

Operation

- Do not place a heavy object on the power cable. It may cause fire or electric shock.
 - Do not change or extend the power cable without authorization. It may cause fire or electric shock.
 - Use the cable exclusive for the product. If an unauthorized or non-standard cable is used, it may cause fire or electric shock.
 - Do not use a heating equipment near the power cable. It may cause fire or electric shock.
 - Do not let water enter inside the product. It may cause electric shock or product failure.
 - Do not place a container with liquid on the product. It may cause product malfunction.
 - Do not touch the product with wet hand. It may cause fire or electric shock.
 - Use standard parts. If unauthorized parts are used, it may cause fire, electric shock, explosion, user injury, or product failure.
 - When the product is flooded, do not use, power off and contact the Service Company. It may cause fire or electric shock.
 - Do not impose shock to the product. It may cause product failure.
 - Do not store or use combustible gas or ignition material near the product. It may cause fire or product failure.
 - Do not disassemble, repair, or modify the product without authorization. It may cause fire or electric shock.
 - Provide adequate supervision for use of the product by children or elderly. The negligence may cause safety accident or product failure.
 - Safeguard the product from Children. It may cause product damage to the product or injury of the child.
 - Check the operation temperature boundary stated in the manual before using the product. If there is no usage boundary stated in the manual, use it in the boundary of 0 °C~ 40 °C (32 °F ~ 104 °F). If it is used in an environment exceeding the operation temperature boundary, it will seriously damage the product.
 - Do not press the switch or button of the product with a sharp object. It may cause electric shock or product failure.
 - Before cleaning, power off the product.
- If there is an abnormal sound, smell, or smoke from the product, stop using the product. It

may cause fire or electric shock.

- Do not place a heavy object on the product. It may cause product failure.
- Do not directly spray water on the product or wipe the product with wet towel, etc. It may cause fire or electric shock.
- Do not use the product for special usage such as animal or plant, precision equipment, or preservation of art pieces, and do not use the product at a place unsuitable for the installation. It may cause property damage.
- Safely dispose of the packaging material. If it is not disposed, the remaining packaging material may cause injury to the user.
- When you pull out the power plug, hold the head of the plug, and do not touch the power plug with wet hand. - It may cause fire or injury.
- Make sure to cut off the power of the product during the cleaning or repair. It may cause fire or product deformation.



CAUTION

Installation

- Install the product firmly on a place that can support the weight of the product. The product may fall and be damaged.
- Do not use the product at a place with grease, steam, or sulphuric acid gas. It may cause product performance degradation or product damage.
- Check the rated power. It may cause fire or product failure.
- Please use the adaptor provided where necessary. If non-standard adaptor is used, it may cause product failure.
- During the transportation of the product, be careful not to drop or damage the product. It may cause product failure or injury of the transporting person.
- During the wiring, do not let dew, water, insect, etc. enter the connection part where the cable is extended. If an foreign object enters, it may cause electric shock or product failure.

Operation

- When cleaning the product, do not use strong detergent such as solvents, wipe with a soft cloth instead. If strong detergent such as solvents are used, it may cause a fire or the product may be deformed.
- Do not press the touch panel with a pointed or sharp object. It may cause electric shock or product failure.
- Do not let a metal material touch the product. It may cause product failure.
- Before cleaning, power off the product. It may cause malfunction of the product.
- Do not touch anything inside the product. It may cause product failure.
- After a long period of product use, check it for any wear and tear or damage. When the product is used for a long period of time, the product status may become worn or damaged, and it may cause user injury during the usage.
- Do not store the product near liquid such as a vase or water jar. It may cause fire or electric shock.
- When the product is not used for a long period of time, turn off at the main power switch. It may cause fire or product failure.

COMPONENTS

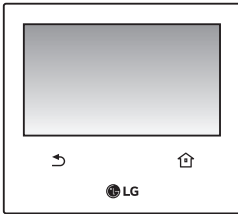
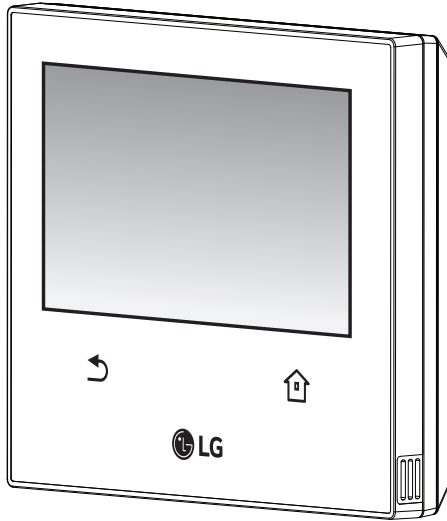

AC Ez Touch
Controller

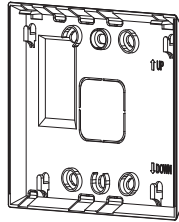

Wall installation plate

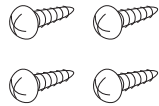

Wall installation screw

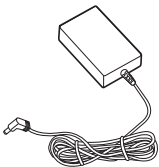

Power adapter

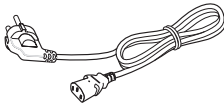

Power cord



Installation / User manual



! NOTE

The image of components or separately sold products may be different from the actual products.

PRODUCT SPECIFICATION

AC Ez Touch product specification is as follows.

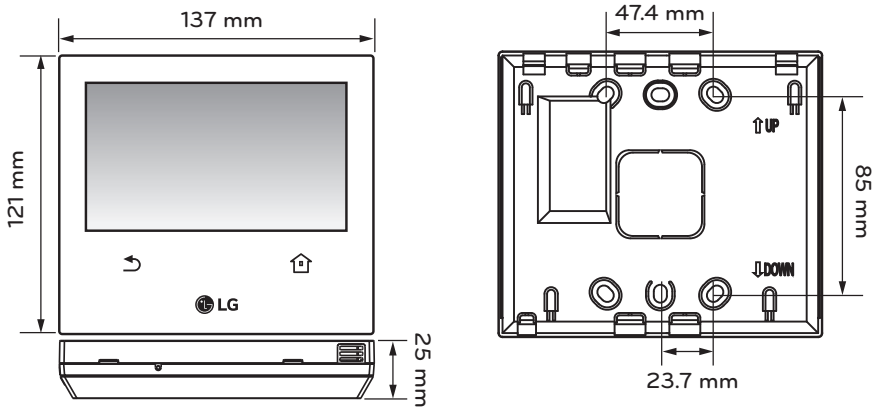

Item	Specification
Power	DC 12 V (Adapter)
Adapter	Input : 100-240 V~, 50 / 60 Hz , 1.2 A Output : DC 12 V, 3.33 A
LCD	5 inch color LCD (800 * 480)
Touch	C-Type Touch Panel
485 communication	Max 1 000 m
DI	Max 100 m
Ethernet	100 Mbps
Keyboard	Korean/English/Number
Operation temperature	0 °C ~ 40 °C (32 °F ~ 104 °F)
Storage temperature	-20 °C ~ 60 °C (-4 °F ~ 140 °F)

NAME OF EACH PART

Name

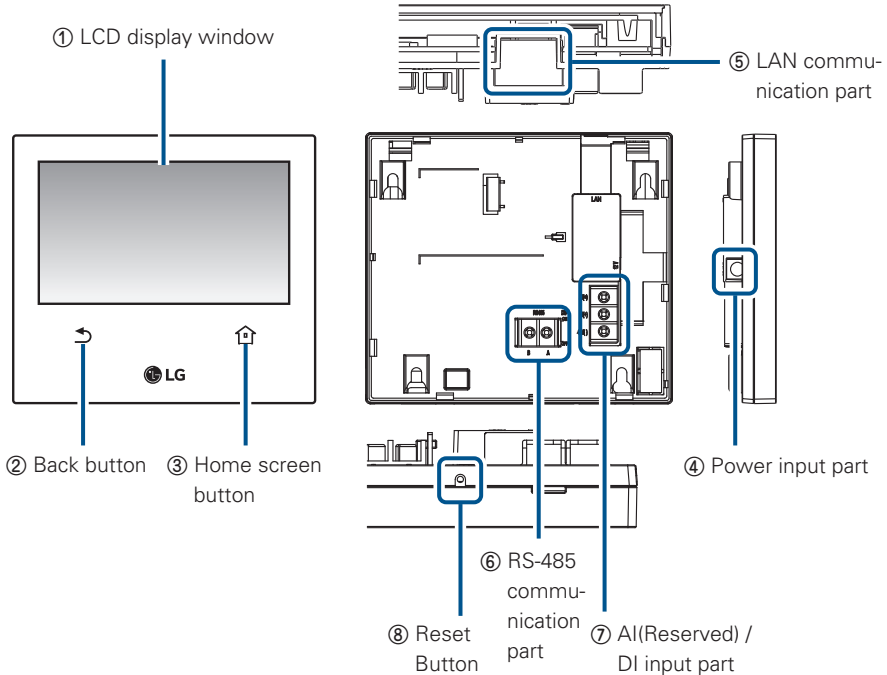

No.	Item	Specification
①	LCD display window	Operation and setting status display
②	Back button	Move to the previous screen
③	Home screen button	Move to the default screen
④	Power input part	DC 12 V Adaptor connection part
⑤	LAN communication part	LAN communication connection port for ethernet connection (100 Mbps Support)
⑥	RS-485 communication part	1 port
⑦	AI/DI Input part	AI+ : Reserved DI+ : Contact point input (dry contact input) COM : Common GND
⑧	Reset button	For system restart

HOW TO USE

Menu composition

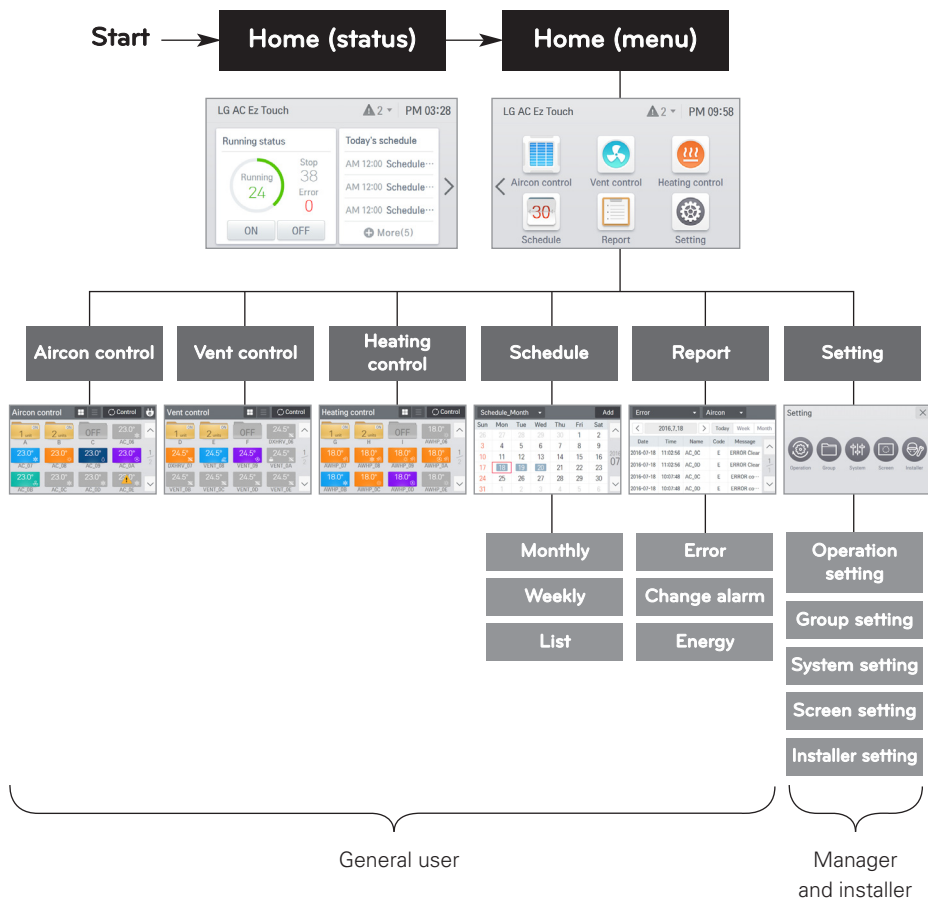

Access rights for each menu

Detail access rights

- General user: can access all menu displayed in the screen.
- Manager and installer: When it enters the setting, the manger and installer are verified by password.

Home screen composition and function

It describes the home screen composition and function.
The home screen is divided to status screen and menu screen.

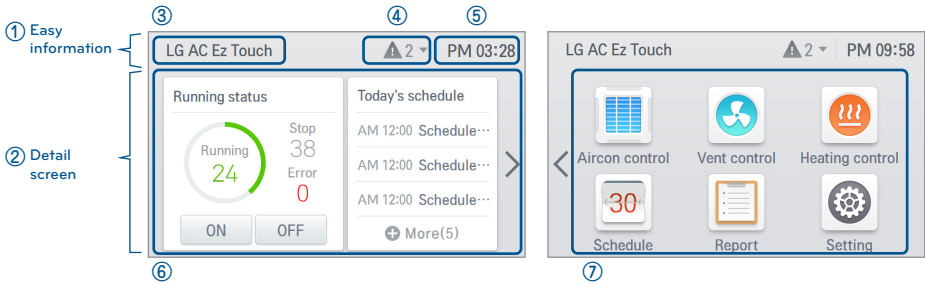

No.	Item	Specification
①	Easy information	Controller name / error message / current time
②	Detail screen	Provides operation status and today's schedule
③	Controller name	Displays the controller name (can edit in 'Setting > System setting > General > Controller name')
④	Error message	It displays the current number of the errors that occurred, and it displays the detail screen when the top bar is pressed.
⑤	Current time	Current time display (can edit in 'Setting > System setting > General > Time setting')
⑥	Status screen	Provides today's schedule / entire equipment operation status
⑦	Menu screen	Provides menu for detail control / setting

Top bar detail screen

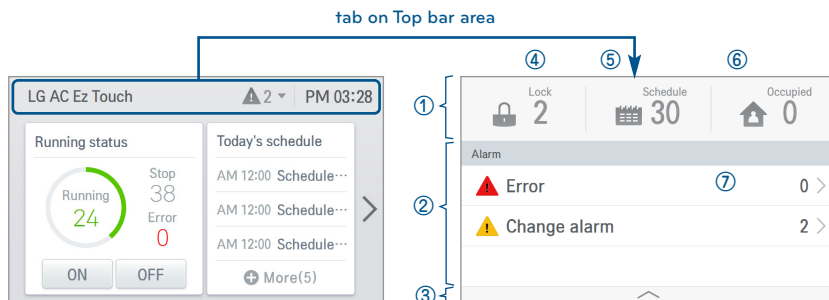

No.	Item	Specification
①	Setting status	Set function list area
②	Notice list	Displays the number of each notice (error, oil change, filter change)
③	Close	When it is selected, the notice list area is closed
④	Lock	Displays the number of locked (entire lock) devices
⑤	Schedule	Displays the number of the entire schedules
⑥	Occupied	Displays the number of currently occupied equipments (applied only for overseas model)
⑦	Detail display	Error: move to the error report menu Change alarm: move to the change alarm report menu - Oil change / Filter change

Status screen

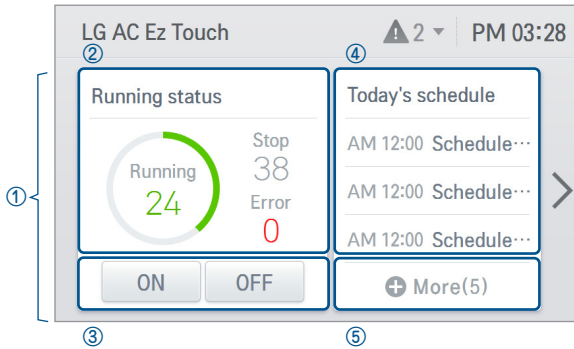

No.	Item	Specification
①	Status screen	Provides today's schedule / operation status as fixed display
②	Operation status	Displays the number of entire indoor unit (Air conditioner + Ventilation + Heating) operation/stop/error
③	Entire control	Entire indoor unit (Air conditioner + Ventilation + Heating) operation/stop control
④	Today's schedule	Sort today's schedule in timely order - displays time information and name of the schedule
⑤	Schedule	- If there are 4 or more today's schedules, "More" button is displayed - If "More" button is pressed, it moves to "Schedule> Monthly" screen

Displays the screen according to the number of today's schedules

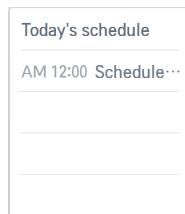

If the schedules are 3 or less

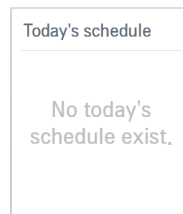

If there is no schedule

Menu screen

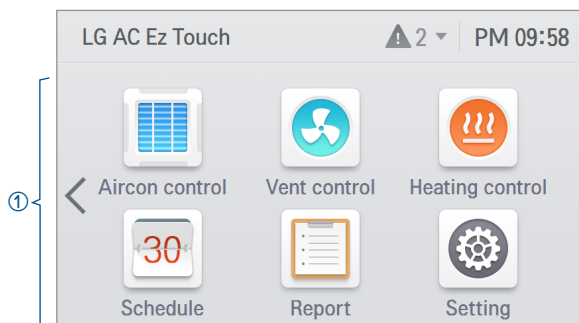

No.	Item	Specification
①	Menu screen	<p>The component of menu is different depending on the type of the connected equipment.</p> <p>When the menu is selected, it moves to the control screen.</p> <p>* In case of the menu screen, the location of the menu changes according to the connected product.</p>

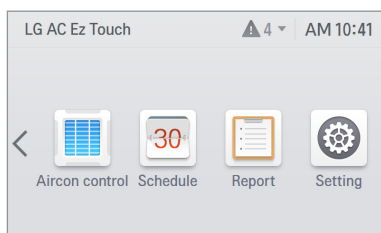

<In case when
Only air conditioner is connected>

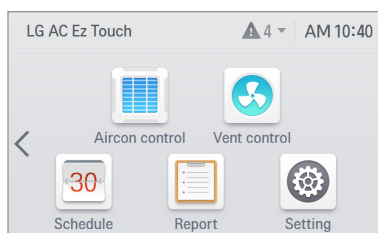

<When air conditioner and ventilation
are connected>

Control screen

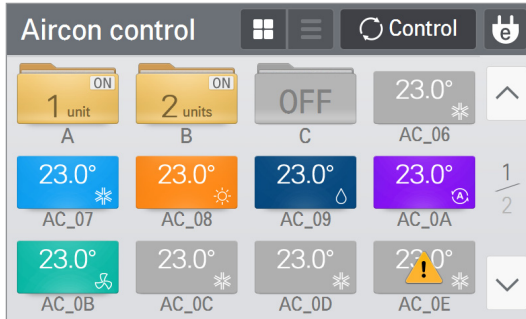

1. Equipment display area

- It displays group and individual equipment in 3*4 matrix.
- It is positioned at the top when a group is created.

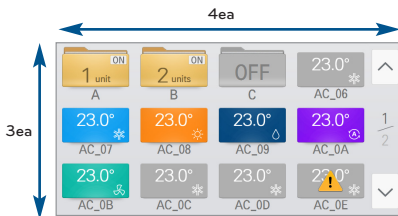

<Group/individual equipment position>

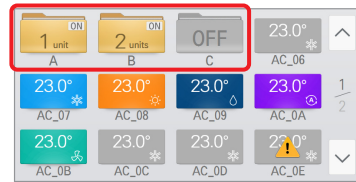

<It is positioned at the top when a group is created>

2. Equipment name display

- When an equipment is selected, a detail status screen appears. (The number of letters for the equipment name set in the installer setting device management is restricted to 20.)

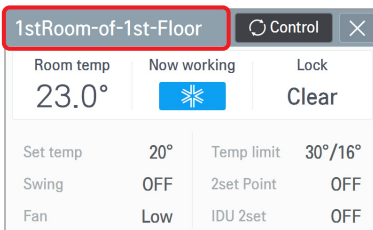

<Equipment detail status screen>

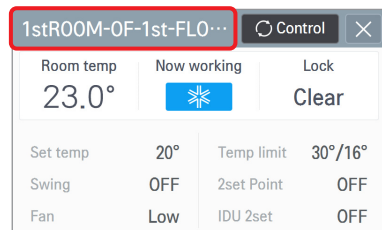

<Equipment name abbreviation display screen>

3. Page move button

- It is activated when the control screen's number of equipment or groups is 13 or more.
- Current page number / entire number of pages and buttons

4. Group / equipment display

- Group

If the corresponding group's equipment is on, it displays the number of turned on equipments (ON N equipments).

If all of the equipment in the corresponding group are turned off, it displays stop text.



- Individual Air conditioner

Displays indoor temperature, operation mode, and status icon (lock / occupied).

If it is stop state, it is displayed in gray, and the color is displayed differently for each mode. Cool(blue), Heat(orange), Fan(green), Dry(dark blue), Auto(purple)



- Individual Ventilation(ERV/ERV DX)

Displays indoor temperature, operation mode, and status icon (lock).

If it is stop state, it is displayed in gray, and the color is displayed differently for each mode. Normal(blue), HEX(orange), Auto(purple)



- Individual Heating

Displays indoor temperature, operation mode, and status icon (lock).

If it is stop state, it is displayed in gray, and the color is displayed differently for each mode. Cool(blue), Heat(orange), Auto(purple)



! NOTE

In case of Heating Device

- If hot water operation is 'ON', the icon is displayed as in operation even if operation is in OFF state.
- If hot water operation is 'ON', the icon is displayed as heating color regardless of the actual mode.

5. When an error occurs

- Error icon is displayed.
- In case of a group, if there is at least 1 indoor unit with error in the group, it is applied.

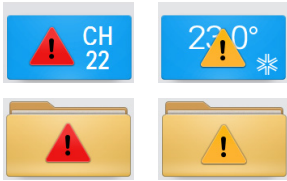

Item	Specification
	When an error occurs
	In case of oil/filter change alarm

* If error, oil change alarm, and filter change alarm occur at the same time, the error is displayed with the priority. Error alarm has a high priority.

6. When [Energy save mode] icon is pressed

When [Energy save mode] icon in the Air conditioner control screen is pressed, the energy save mode becomes on.

When the energy save mode is on, the [Energy save mode] icon is lighted in green, and the operation state change control is repeated according to the setting of energy save mode cycle.

* Energy save mode operates the air conditioner only.

- During the cooling operation: Cool ↔ Fan, Lock all
- During the heating operation: Heat ↔ OFF, Lock all

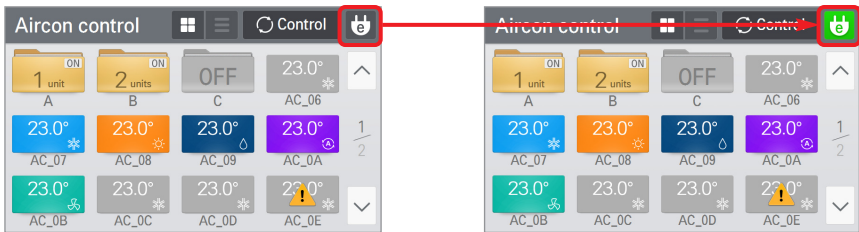

NOTE

In slave state, you cannot use each equipment's lock setting, set temp range, 2set point, IDU 2set, auto search device function, energy report and energy save mode.

Information input method

A touch keyboard appears at the bottom of the screen by touching the information input column. Enter information using the touch keyboard.

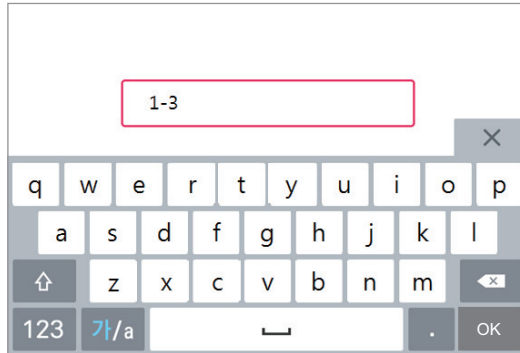

< Keyboard display screen >

! NOTE

When you press number input field, you can directly input the number for the setting.

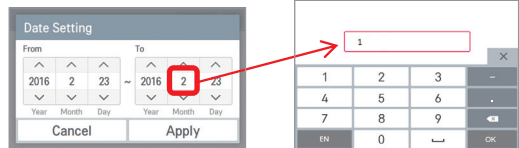

Air conditioner control

In this screen, you can control the air conditioner indoor unit group/individual equipment or check the status.

- When you press  **Control** button, selection box to control group/individual equipment appears.

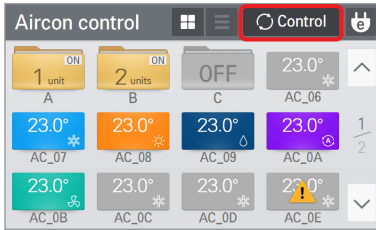

<Status view screen>

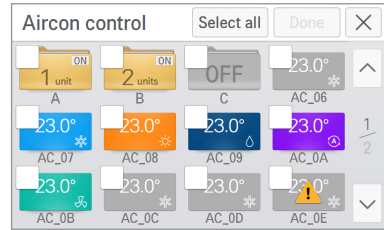

<Control screen>

- After selecting the equipment to control, when you press  **Done** button, it enters the detail control screen.

- In the detail control screen, set the detail status.

- After changing the setting in the detail control screen, when you press  **Apply** button, the control command is executed.

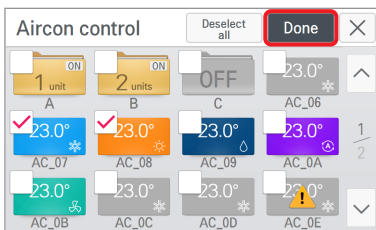

<Select equipment to control>

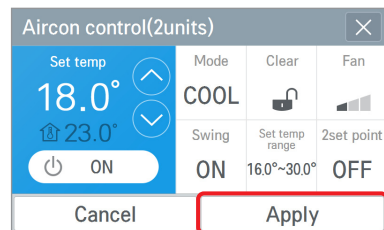

<Detail control screen>

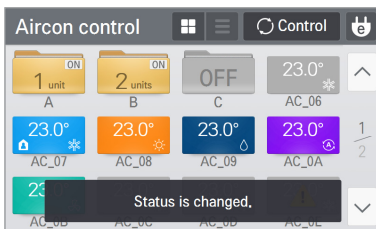

<Control completed message display>

<General control category>

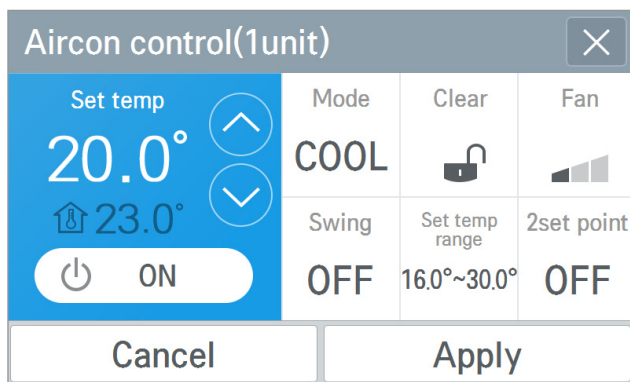

Classification	Detail control
Operation	ON/OFF
Set temp	18 °C ~ 30 °C / 64 °F ~ 86 °F
Mode	COOL/HEAT/DRY/FAN/AUTO
Lock	Hard Lock/Temp Lock/Mode Lock/Fan Lock/Clear
Fan speed	Low/Med/High/Auto
Swing	ON/OFF
Set temp range	Lower: 16 °C ~ 30 °C / 60 °F ~ 86 °F Upper: 18 °C ~ 30 °C / 64 °F ~ 86 °F (Even if the temperature display setting is in Celsius / 0.5 °C unit, setting is possible only in 1 °C unit.)
2set point / IDU 2set	ON/OFF (Refer to the description for the auto mode option setting / operation setting.)

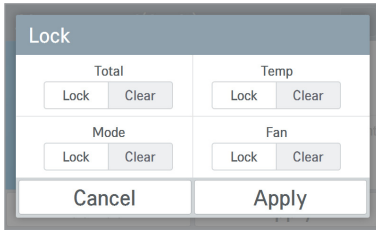

<Lock setting screen>

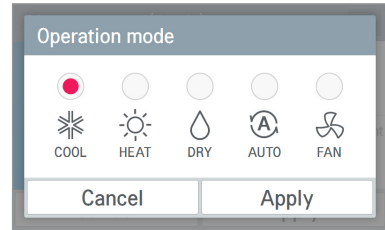

<Control mode setting screen>

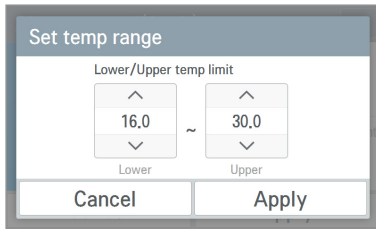

<Temperature limit setting screen>

! NOTE

According to the product type, some additional functions may not be displayed or not operational. In slave state, you cannot use each equipment's lock setting, set temp range, 2set point, IDU 2set, auto search device function, energy report and energy save mode.

<Auto control setting category>

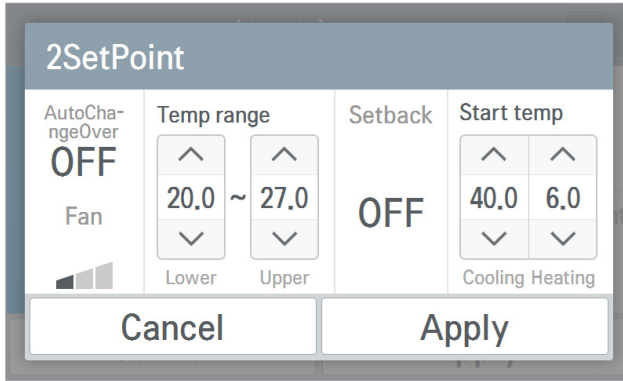

<AutoChangeover/Setback setting screen>

Classification		Detail control
Auto Changeover	Whether used	ON/OFF
	Fan	Low/Med/High/Auto
	Temp range	Lower: 18 °C ~ 30 °C / 64 °F ~ 86 °F Upper: 18 °C ~ 30 °C / 64 °F ~ 86 °F
Setback	Whether used	ON/OFF
	Start temp	Cooling: 21 °C ~ 40 °C / 70 °F ~ 104 °F Heating: 1 °C ~ 20 °C / 34 °F ~ 68 °F

NOTE

In slave state, you cannot use each equipment's lock setting, set temp range, 2set point, IDU 2set, auto search device function, energy report and energy save mode.

<Advanced setting category>

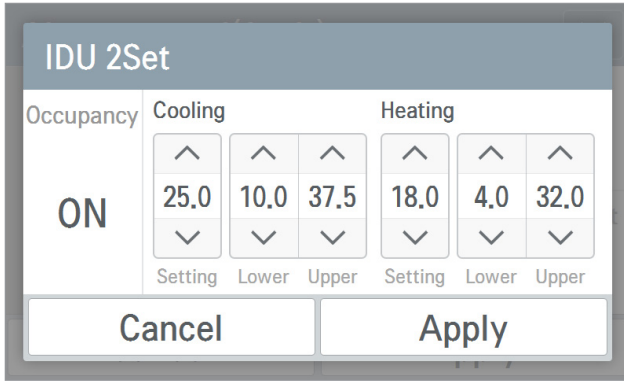

<2set Auto mode setting screen>

Classification	Detail control
Occupancy setting	ON(Occupied)/OFF(Unoccupied)
Cool set temperature	10 °C ~ 37.5 °C / 50 °F ~ 99 °F
Cool upper temperature	10 °C ~ 37.5 °C / 50 °F ~ 99 °F
Cool lower temperature	10 °C ~ 37.5 °C / 50 °F ~ 99 °F
Heat set temperature	4 °C ~ 32 °C / 40 °F ~ 90 °F
Heat upper temperature	4 °C ~ 32 °C / 40 °F ~ 90 °F
Heat lower temperature	4 °C ~ 32 °C / 40 °F ~ 90 °F

! NOTE

- 2set auto mode is a US-only option.

Only indoor and outdoor group 2set support the automatic mode, you can use the feature.

(please refer to the manual for that device, whether it supports 2set function for each device.)

- 2set auto mode should be set in Settings> Operation Settings> Auto Mode option menu, you can use the feature.

- In slave state, you cannot use each equipment's lock setting, set temp range, 2set point, IDU 2set, auto search device function, energy report and energy save mode.

Ventilation(ERV and ERV DX) control

In this screen, you can control Ventilation(ERV and ERV DX)'s group/individual equipment or check the status.

- When you press **Control** button, selection box to control group/individual equipment appears.

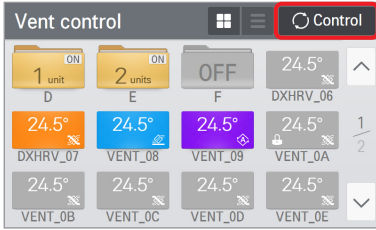

<Status view screen>

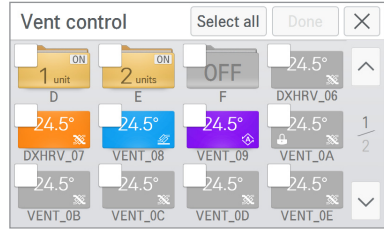

<Control screen>

- After selecting the equipment to control, when you press **Done** button, it enters the detail control screen.
 - In the detail control screen, set the detail status.
- After changing the setting in the detail control screen, when you press **Apply** button, the control command is executed.

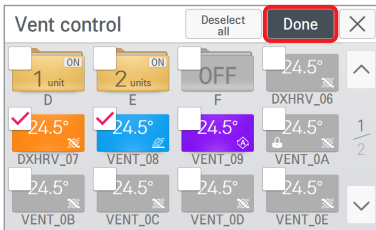

<Select equipment to control>

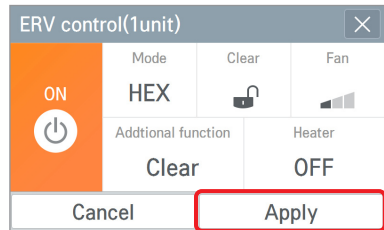

<ERV detail control screen>

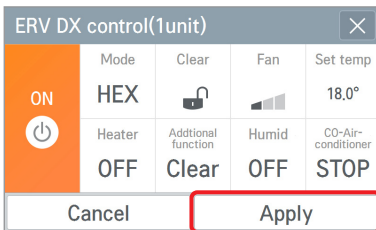

<ERV DX detail control screen>

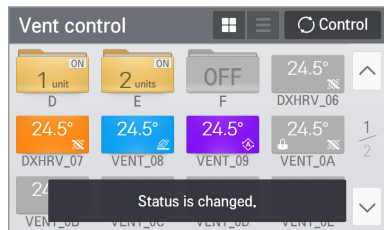

<Control completed message display>

<General control category>

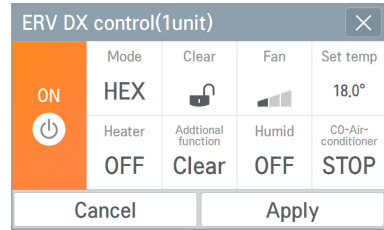
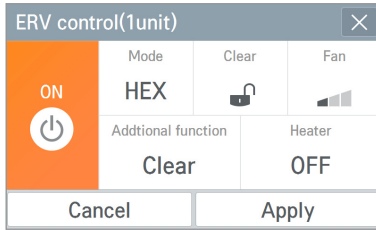

Classification	ERV	ERV DX
Operation	ON/OFF	ON/OFF
Mode	HEX/NORMAL/AUTO	HEX/NORMAL/AUTO
Lock	Lock/Clear	Lock/Clear
Fan	Low/High/Super/Auto	Low/High/Super/Auto
Set temp	-	18 °C ~ 30 °C / 64 °F ~ 86 °F (Even if the temperature display setting is in Celsius / 0.5 °C unit, setting is possible only in 1 °C unit.)
Additional function	Drift/Quick/Clear	Drift/Quick/Clear
Heater	ON/OFF	ON/OFF
Humid	-	ON/OFF (Setting is possible only in air conditioner heat mode operation.)
Co-Air conditioner	-	COOL/HEAT/AUTO/STOP

! NOTE

According to the product type, some additional functions may not be displayed or not operational. When ERV and ERV DX are selected at the same time, the ERV control screen is displayed.

Heating control

In this screen, you can control the heating's group / individual equipment or check the status.

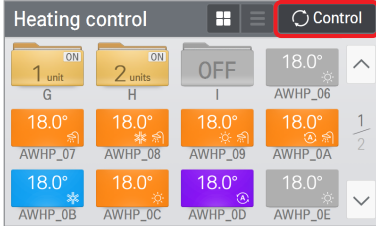

- When you press  **Control** button, selection box to control group/individual equipment appears.

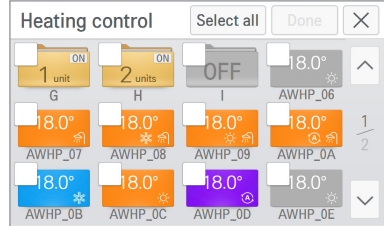

<Status view screen>



<Control screen>

- After selecting the equipment to control, when you press  **Done** button, it enters the detail control screen.
 - In the detail control screen, set the detail status.
- After changing the setting in the detail control screen, when you press  **Apply** button, the control command is executed.

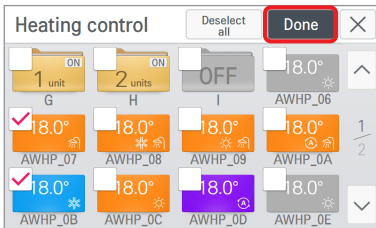

<Select equipment to control>

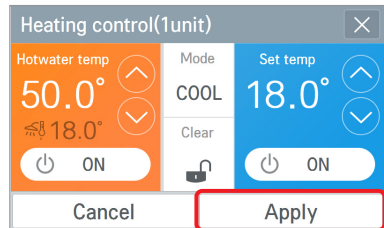

<Detail control screen>

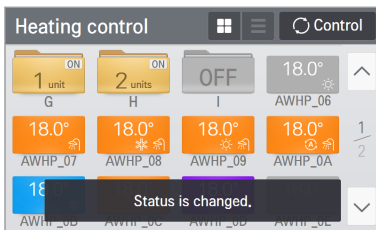

<Control completed message display>

<General control category>

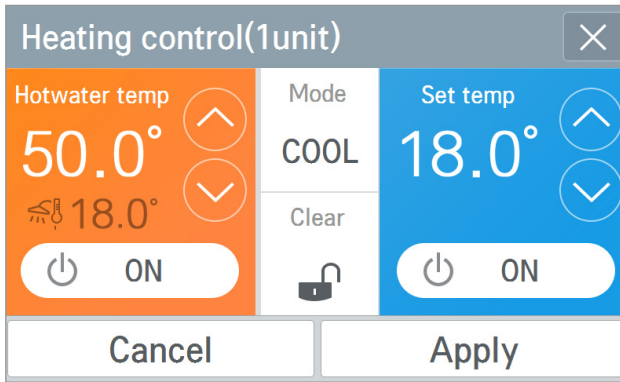

Classification	Detail control
Operation	ON/OFF
Hot water	ON/OFF
Lock	Lock/Clear
Mode	COOL/HEAT/AUTO
Set temp	<p>Product type</p> <p>1) WHU[Hydrokit] Air temp (Cool) : 18 °C ~ 30 °C / 64 °F ~ 86 °F Air temp (Heat) : 16 °C ~ 30 °C / 60 °F ~ 86 °F Water temp(Cool) : 6 °C ~ 25 °C / 42 °F ~ 77 °F Water temp(Heat) : 20 °C ~ 50 °C / 68 °F ~ 122 °F</p> <p>2) SINGLE_AWHP Air temp (Cool) : 16 °C ~ 30 °C / 60 °F ~ 86 °F Air temp (Heat) : 16 °C ~ 30 °C / 60 °F ~ 86 °F Water temp(Cool) : 6 °C ~ 25 °C / 42 °F ~ 77 °F Water temp(Heat) : 20 °C ~ 55 °C / 68 °F ~ 131 °F</p> <p>3) CASCADE Air temp (Heat) : 16 °C ~ 30 °C / 60 °F ~ 86 °F Water temp(Heat) : 30 °C ~ 80 °C / 86 °F ~ 176 °F</p> <p>4) HEAT_ONLY_AWHP Air temp (Heat) : 16 °C ~ 30 °C / 60 °F ~ 86 °F Water temp(Heat) : 15 °C ~ 80 °C / 59 °F ~ 176 °F</p>
Hot water temp	<p>Product type</p> <p>1) WHU[Hydrokit] : 30 °C ~ 50 °C / 86 °F ~ 122 °F 2) SINGLE_AWHP : 30 °C ~ 80 °C / 86 °F ~ 176 °F 3) CASCADE : 30 °C ~ 80 °C / 86 °F ~ 176 °F 4) HEAT_ONLY_AWHP : 30 °C ~ 80 °C / 86 °F ~ 176 °F</p>

NOTE

According to the product type, some additional functions may not be displayed or not operational.

Schedule view

This screen views the monthly/weekly/list of the schedule.
The default schedule screen display is monthly.

- Monthly view: You can see monthly set schedules at a glance.
- Weekly view: You can see weekly set schedules at a glance.

You can check the start time of the schedule and the set operation mode.

- List view: You can check the entire set schedule list.

You can check the number of equipment that will be operated in the set schedule.

Schedule_Month							Add
Sun	Mon	Tue	Wed	Thu	Fri	Sat	
26	27	28	29	30	1	2	
3	4	5	6	7	8	9	
10	11	12	13	14	15	16	2016 07
17	18	19	20	21	22	23	
24	25	26	27	28	29	30	
31	1	2	3	4	5	6	

<Monthly view>

Schedule_Week								Add	
<		2016.08.07 ~ 2016.08.13				>		1Hour	6Hour
	7Su	8Mo	9Tu	10We	11Th	12Fr	13Sa		
00:00			Schedule (1)		Schedule (2)				
01:00									
02:00									
03:00									
04:00									

<Weekly view>

Schedule_List		Edit
Schedule (1)	1 unit	>
Schedule (2)	25 units	>
Schedule (3)	6 units	>
Schedule (4)	22 units	>
Schedule (5)	20 units	>

<List view>

Add schedule

1. Press the **Add** button.

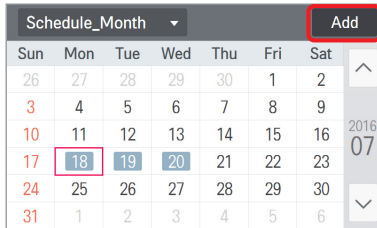

2. Input the basic schedule information.

Add schedule	
Phase1. Input basic schedule information.	
Name (50) Schedule (6)	Period 2016.07.18 ~ 2016.07.18
Time AM 12:00	Repeat Everyday

After the input, press **Next >** button.

<Name setting>

<Date setting>

<Time setting>

<Repeat setting>

3. Input additional equipment and detail setting values.

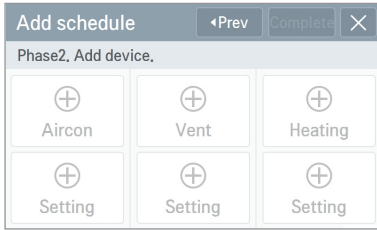

<Select Air conditioner>

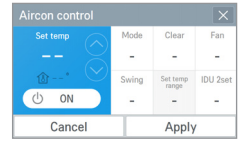

<Setting value input screen>

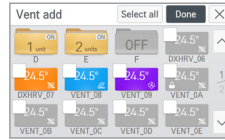

<Select Ventilation>

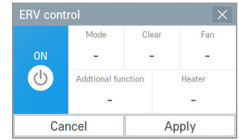

<Setting value input screen>

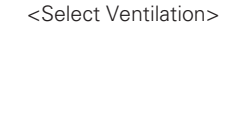

<Setting value input screen>

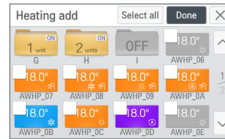

<Select Heating>

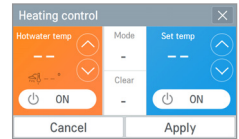

<Setting value input screen>

4. When you press **Complete** button, the schedule is saved.

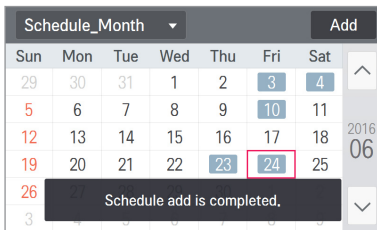

NOTE

If repeat pattern is set not to use, the set period is fixed to today's date. When ERV and ERV DX are selected at the same time, the ERV control screen is displayed.

Edit schedule

1. Select the schedule to edit.

Schedule_Month							Add
Sun	Mon	Tue	Wed	Thu	Fri	Sat	
26	27	28	29	30	1	2	2016 07
3	4	5	6	7	8	9	
10	11	12	13	14	15	16	
17	18	19	20	21	22	23	
24	25	26	27	28	29	30	
31	1	2	3	4	5	6	

2. Press button at the bottom.

Schedule (2)		
Date	2016.07.18 ~ 2016.07.18	Aircon (01) *
Time	AM 01:00	1/2
Repeat	Repeat	
Day	Everyday	
Delete		Edit
		OK

3. Change the basic schedule information.

Edit schedule		Next >	X
Phase1. Input basic schedule information.			
Name (50)	Period		
Schedule (2)	2016.07.18 ~ 2016.07.18		
Time	Repeat		
AM 01:00	Everyday		

After the input, press button.

Name setting (50)	
Schedule (6)	
Cancel	Apply

<Name setting>

Date setting	
From	To
2016 7 18	2016 7 18
Year Month Day	Year Month Day
Cancel	Apply

<Date setting>

Time setting	
AM	12 00
Hour	Minute
Cancel	Apply

<Time setting>

Repeat setting	
Repeat	MON TUE WED THU
ON	FRI SAT SUN
Cancel	Apply

<Repeat setting>

4. Add equipment and change detail setting values.

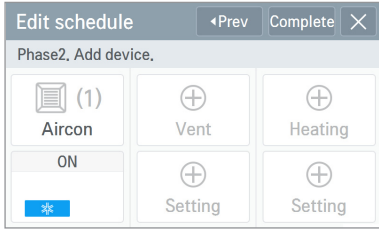

<Select Air conditioner>

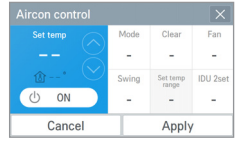

<Setting value input screen>

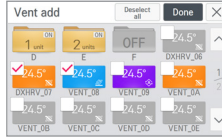

<Select Ventilation>

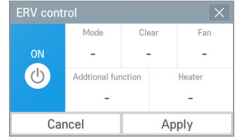

<Setting value input screen>

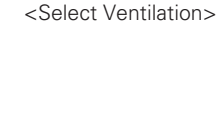

<Setting value input screen>



<Select Heating>

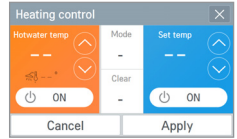

<Setting value input screen>

5. When you press **Complete** button, the schedule is saved.

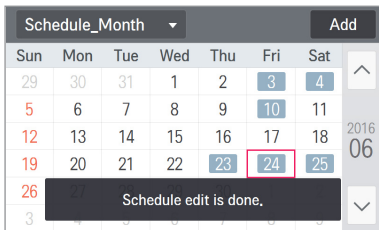

Delete schedule

1. Select the schedule to edit.

Schedule_Month							Add
Sun	Mon	Tue	Wed	Thu	Fri	Sat	
26	27	28	29	30	1	2	^
3	4	5	6	7	8	9	
10	11	12	13	14	15	16	2016 07
17	18	19	20	21	22	23	
24	25	26	27	28	29	30	
31	1	2	3	4	5	6	v

2. Press button at the bottom.

Schedule (2)		X
Date	2016.07.18 ~ 2016.07.18	Aircon (01) *
Time	AM 01:00	1/2
Repeat	Repeat	2
Day	Everyday	v
<input type="button" value="Delete"/>		<input type="button" value="Edit"/>
		<input type="button" value="OK"/>

3. In the whether to delete check screen, press button.

Delete
Do you want to delete the selected schedule?
<input type="button" value="Cancel"/> <input type="button" value="Apply"/>

4. The schedule is deleted.

Schedule_Month							Add
Sun	Mon	Tue	Wed	Thu	Fri	Sat	
26	27	28	29	30	1	2	^
3	4	5	6	7	8	9	
10	11	12	13	14	15	16	2016 07
17	18	19	20	21	22	23	
24	Delete schedule is done.						
31							v

View report

This screen views the occurred error information, filter / oil change alarm information and energy information.

- Error: Displays the error report.

(You can view each error report of Air conditioner/Ventilation/Heating.)

It displays [date / time / device name / error code / message] of the occurred error.

When you select the error contents, you can check the detail error information.

Error		Aircon	
< 2016.5.27 > Today Week Month			
Date	Time	Name	Code Message
2016-05-27	16:52:30	AC_08	E ERROR Clear
2016-05-27	16:52:30	AC_09	E ERROR Clear
2016-05-27	14:53:12	AC_09	E ERROR co...
2016-05-27	14:53:11	AC_08	E ERROR co...

<View entire error report>

Detail			
Date	2016-05-27	Name	AC_09
Time	14:53:12	Code	E
Desc	ERROR code = 242		
OK			

<View detail error information>

- Change alarm: It displays the occurred filter / oil change alarm report.

It displays [date / time / device name / message] of the occurred alarm.

When you select the alarm contents, you can check the detail change alarm information.

Change alarm		Oil	
< 2016.5.27 > Today Week Month			
Date	Time	Name	Message
2016-05-27	10:24:27	AC_0C	oil alarm
2016-05-27	10:24:15	AC_0E	oil alarm
2016-05-27	10:24:14	AC_0D	oil alarm
2016-05-27	10:24:13	AC_0B	oil alarm

<View entire change alarm report>

Detail			
Date	2016-05-27	Name	AC_0C
Time	10:24:27	Code	0
Desc	oil alarm		
OK			

<View detail change alarm information>

- Energy: It displays the energy report.

You can check the power consumption and accumulated power consumption of group / individual equipment.

When you select the energy contents, you can check the detail energy information.

Energy			
<		2016.7.24	>
		Today	Week
		Month	
Name	Usage(kWh)	Accum(kWh)	
Total	20,0	20,0	
A	1,0	1,0	1/14
B	2,0	2,0	
C	3,0	3,0	

<View entire energy report>

Energy			
<		2016.7.24	>
		Today	Week
		Month	
A		1,0/1,0	Prev.
Name	Usage(kWh)	Accum(kWh)	
AC_00	1,0	1,0	1/1

<View detail energy information of group>

Energy			
<		2016.7.18	>
		Today	Week
		Month	
Name	Usage(kWh)	Accum(kWh)	
AC_09	10,0	10,0	4/17
AC_0A	10,0	10,0	
AC_0B	10,0	10,0	
AC_0C	10,0	10,0	

<View entire energy report>

Detail	
AC_09	
Usage(kWh)	Accum(kWh)
10.0	10.0
OK	

<View detail energy information of device>

! NOTE

In slave state, you cannot use each equipment's lock setting, set temp range, 2set point, IDU 2set, auto search device function, energy report and energy save mode.

Emergency stop

<Occurrence of emergency stop situation>

The emergency stop function is to stop all connected cooling and heating equipment when an emergency stop situation occurs.

When there is an input to DI port, it stops all connected equipment and shows the emergency stop state as follows.

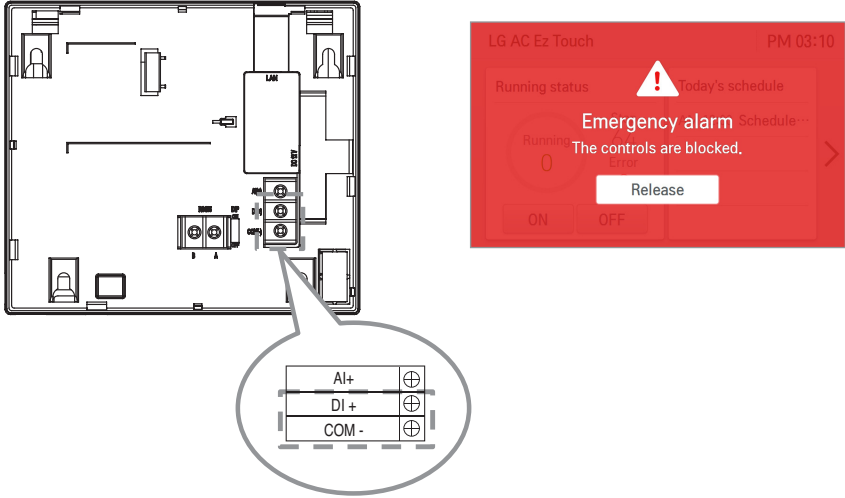

<Cancel emergency stop>

When there is no input to DI port, you can cancel the emergency stop by pressing the emergency stop button.

To cancel the emergency stop state, input the password and press button.

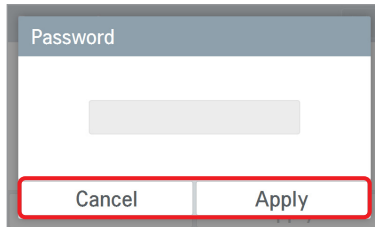

! NOTE

If the password setting is "OFF", you can cancel emergency stop without the password input.

Setting

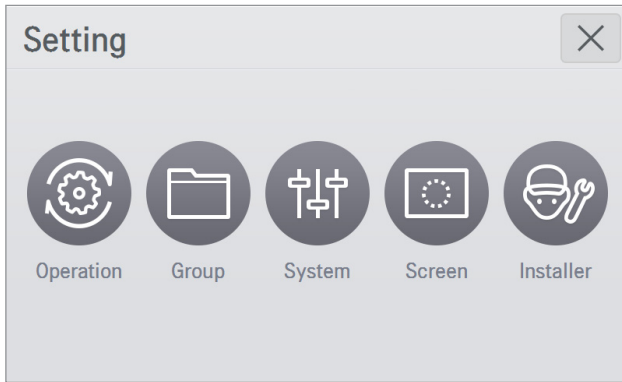

Classification		Detail control
Operation setting		Auto mode option, energy save mode cycle, temperature difference, holiday setting, schedule initialization
Group setting		Equipment group setting (for each Air conditioner/Ventilation/Heating)
System setting	General	Date, time, daylight saving time, controller name, speaker, temperature display, language
	Advance	Network, password, version information, open source license
Screen setting		Theme, screen saver, screen saver waiting time, monitor power waiting time, brightness
Installer setting		LGAP setting, language update, device management

Operation setting

Operation		
Auto mode option 2Set auto mode	Energy save mode cycle 5min	Temperature difference 1.0°
Latest holiday 2016.07.15		Schedule initialization 4 items

<Auto mode option setting>

Auto mode option is set to auto mode and 2set auto mode.

Auto mode supports the setting function for the auto conversion operation and temperature limit operation.

2set auto mode supports the setting function for advanced setting.

(When it is in the auto mode, in the detail control screen, you can select whether to use the auto change over / setback. In 2set auto mode, you can select occupied/unoccupied.)



<Energy save mode cycle setting>

It is the function for power saving, and you can set the Energy save mode cycle [5 minutes / 10 minutes / 15 minutes].

Energy save mode cycle
✕

5min
 10min
 15min

Cancel
Apply

When you press  in the Aircon control screen, the air conditioner energy save mode is turned on, and it repeats the operation state change control in sequence according to the set energy save mode cycle.

* Energy save mode operates the air conditioner only.

- In cooling operation: Cool ↔ Fan, lock all

- In heating operation: Heat ↔ OFF, lock all

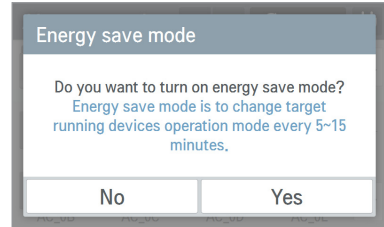
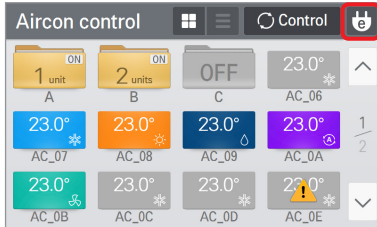

When the energy save mode icon is turned on, the [Energy save mode] icon is lighted in green.

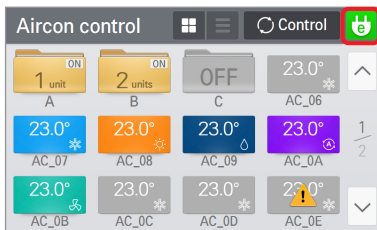

<Temperature difference setting>

When the central auto control operation function is on, you can set the temperature difference.

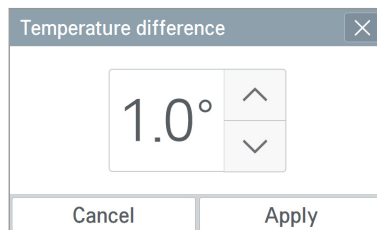

- Celsius : You can set in 0.5 °C unit from 0.5 °C ~ 3.0 °C

Fahrenheit : You can set in 1.0 °F unit from 1.0 °F ~ 6.0 °F

<Holiday setting>

You can set the exception date not to apply the schedule.

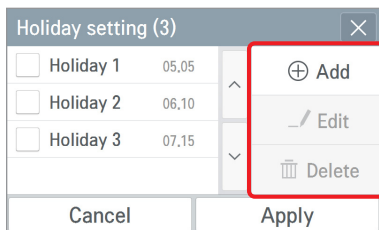

Setting up the exceptional date is applicable only to the corresponding year.

1) Add exception date

- Press **Add** button to enter the addition screen.
- After the input of the name and date of the exception date to add, press **Apply** button.

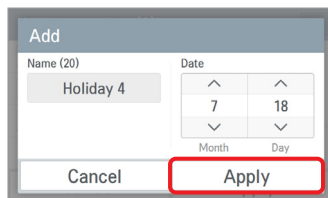

2) Edit exception date

- After selecting the exception date to edit from the list, press **Edit** button.
- After changing the exception date name and date, press **Apply** button.

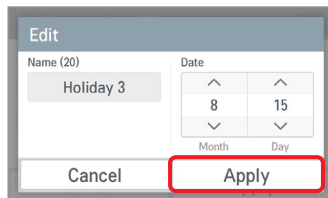

3) Delete exception date

- After selecting the exception date to delete from the list, press **Delete** button.

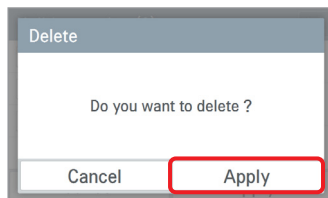

<Schedule initialization>

All currently set schedules are deleted.

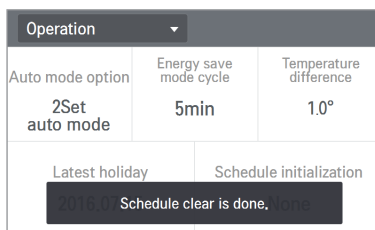
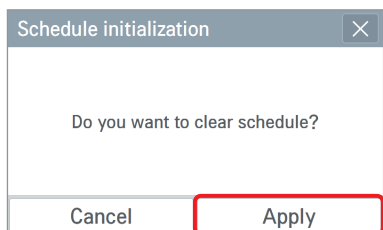

Group setting

You can add a new group to manage, or edit or delete existing indoor unit group.

<Add group>

1. In the group setting screen, select the equipment group to add (Air conditioner/Ventilation/Heating).
2. Press **Edit** button at the top to enter the edit mode.

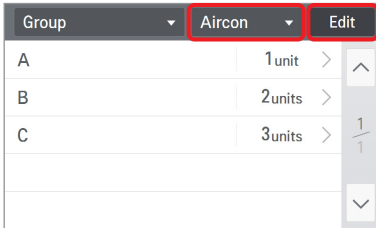

3. Select **Add** button.

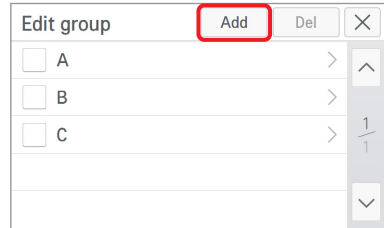

4. In the 1st stage after entering the group add screen, input the group name and press **Next** button at the top.



5. In the 2nd stage, select the equipment to add to the group. (You can select several equipment.)
6. Press **Complete** button at the top.

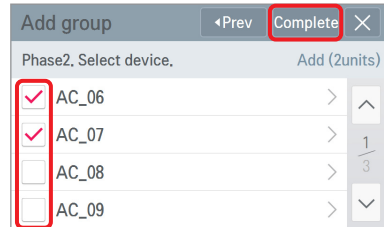

7. It displays the phrase saying that group addition is completed, and the added group appears.

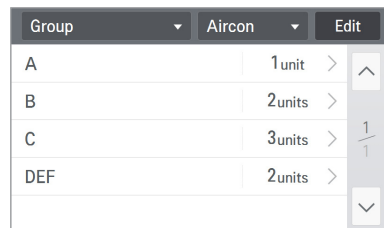
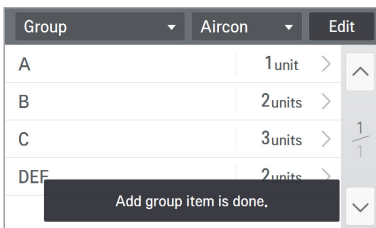

<Edit group>

1. In the group setting screen, select the equipment group (Air conditioner/Ventilation/Heating) to edit and select the group to change in the group list.

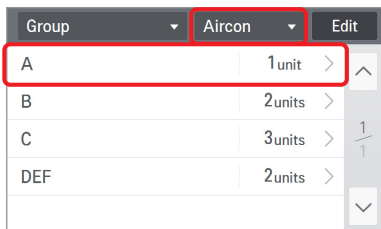

2. Select button.

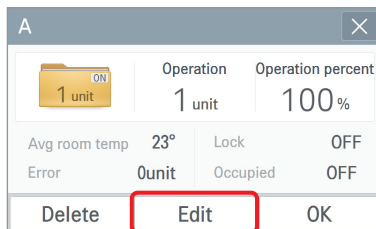

3. Change the group name, and press

button.

If you do not change the group name, directly press button.

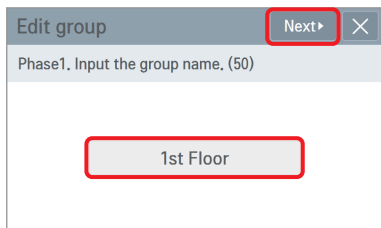

4. Select the equipment to add to the corresponding group.
(You can select several equipment.)

5. Press button at the top.

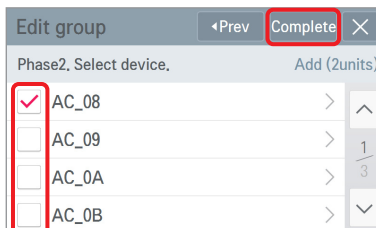

6. It displays the phrase saying that the group edition is completed, and the edited contents are reflected.

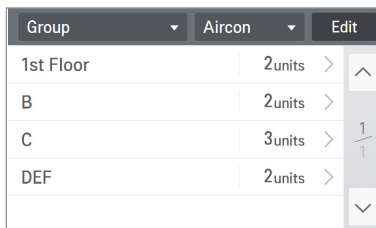
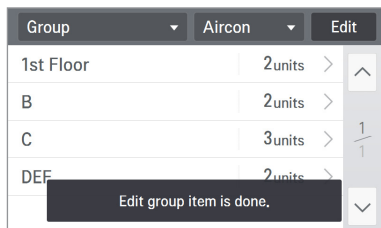

<Delete group>

1. In the group setting screen, select the equipment group (Air conditioner/Ventilation/Heating) to delete from the group.
2. Press **Edit** button at the top to enter the edit mode.

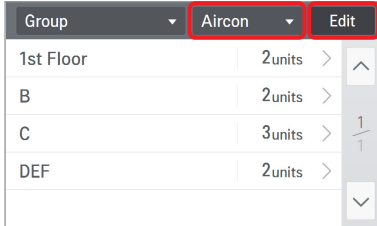

3. Select the group to delete and press **Del** button.

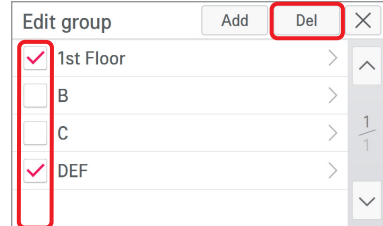

4. In the group deletion verification window, press **Apply** button.

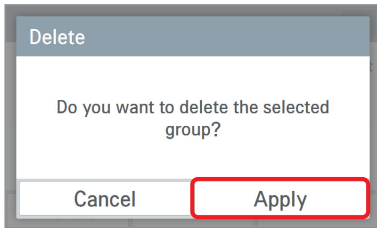

5. It displays the phrase saying that group deletion is completed, and the corresponding group is deleted.

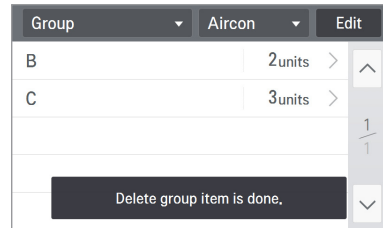

System setting

The system setting is divided to general setting / advanced setting.

System		General	
Date	Time	Daylight	
2016.05.27	PM 02:45	OFF	
Controller name	Speaker	Temperature display	Language
LG AC Ez ...	ON	°C / 1.0°	English

<General setting>

System		Advance	
Network	TMS	Wi-Fi	
DHCP	-	-	
Password	Version information	Open source license	
OFF	Ver. 1.10.3 (Master)		

<Advanced setting>

- In the general setting, you can set the time, date, daylight saving time, controller name, speaker, temperature display, and language.
- In the advanced setting, you can set the network and password, and it displays the version information, open source license.

System setting (General setting)

<Date setting>

In this screen, you can set the current date. After the input of the year / month / day input to set, press button.

Date		
2016	7	18
Year	Month	Day
Cancel	Apply	

* When you change the current date value, the standard date is changed, and the displayed date and schedule interface date, etc. will be operated based on the set date.

<Time setting>

In this screen, you can set the current time. After the input of the AM/PM / hour / minute to set, press button.

Time		
PM	03	53
	Hour	Minute
Cancel	Apply	

* When you change the current time value, the standard time is changed, and the displayed time and schedule interface time, etc. will be operated based on the set time.

<Daylight saving time setting>

In this screen, you can set the date and time to start/end daylight saving time. If the system date/time is reached at the daylight saving time start time, it operates by adding one hour from the current time. Conversely, if the system date/time is reached at the daylight saving time end time, it operates by subtracting one hour from the current time.

Daylight saving time	
Daylight saving time	From Jan / 1st Mon / 01:00
	To Jan / 2nd Mon / 01:00
ON	
Cancel	Apply

<Controller name setting>

In this screen, you can set the name of the currently used controller. After the controller name input, press button.

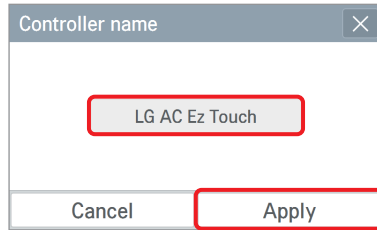

The set name is displayed at the top left side of the home screen.

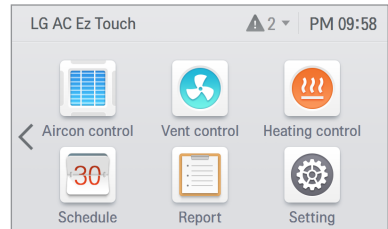
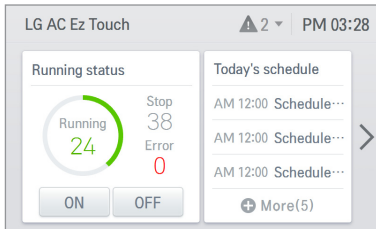

<Speaker setting>

In this screen, you can set whether to use the speaker.

! NOTE

The speaker set-up function is not supported on the PC.

<Temperature display setting>

In this screen, it sets whether to display the temperature in Celsius or Fahrenheit. Select Celsius / Fahrenheit.

Temperature display	
Temperature display	°C Minimum Temp
°C	1.0°
Cancel	Apply

<Celsius>

Temperature display	
Temperature display	°C Minimum Temp
°F	1.0°
Cancel	Apply

<Fahrenheit>

When Celsius is selected, °C minimum temperature display is activated, and please select whether to set the temperature unit to 0.5° or 1.0°.

**<Language setting>**

In this screen, you can set the language to display on the controller. Select the language to use, and press button.

Language	
<input type="radio"/> 한국어	<input type="button" value="Apply"/>
<input checked="" type="radio"/> English	
<input type="radio"/> Italiano	
<input type="radio"/> Español	
Cancel	

System setting (Advanced setting)

<Network setting>

In this screen, you can save or change the network setting information to use when you wish to connect to ethernet.

1) IP address setting

IP address setting methods are using DHCP to get IP address and designating IP address.

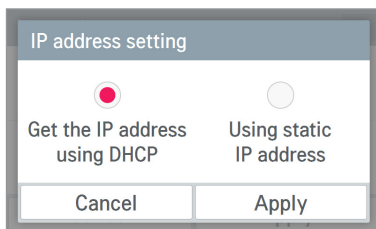

- Get the IP address using DHCP

You can use DHCP to automatically set dynamic IP in the currently connected internet network. (If it is DHCP, IP information setting category is deactivated.)

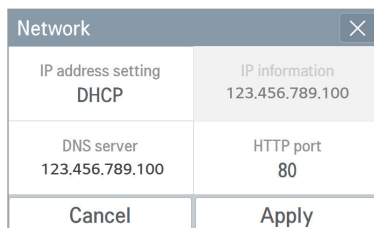

- Using static IP address

You can set the network using the user input IP information. If you select the IP address designation, IP information is activated, and you can input the IP information.

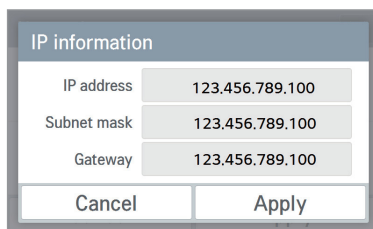
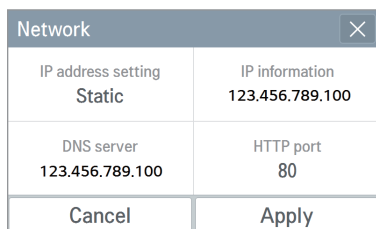

2) DNS server designation

You can set main DNS / sub DNS address.

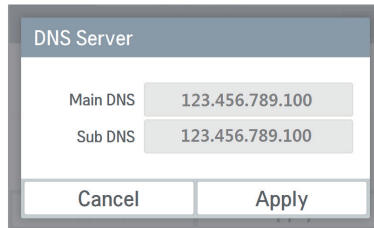

The screenshot shows a dialog box titled "DNS Server". It contains two input fields: "Main DNS" with the value "123.456.789.100" and "Sub DNS" with the value "123.456.789.100". At the bottom, there are two buttons: "Cancel" and "Apply".

3) HTTP port designation

You can change HTTP port setting information for the ethernet connection (for service).

User can freely set HTTP port according to the network environment.

(Input boundary is 1~65535.)

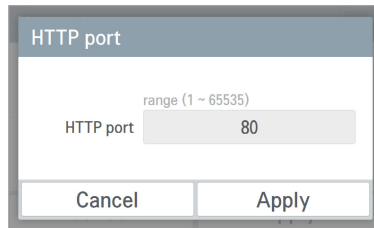

The screenshot shows a dialog box titled "HTTP port". It features a text input field labeled "HTTP port" containing the value "80". Above the input field, the text "range (1 ~ 65535)" is displayed. At the bottom, there are two buttons: "Cancel" and "Apply".

<Password setting>

In this screen, you can initialize or change the password, and when you enter the setting screen, you can set whether to use password.

1. If password is used

1) Select to use the password.

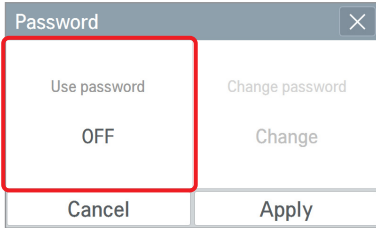

2) Input the previously set password, and press button.

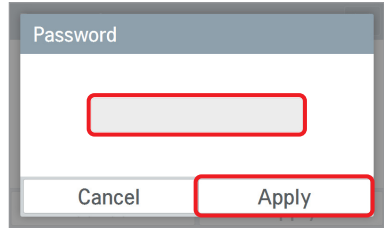

3) It displays that the password is set, and the password is displayed as used.

You need to press button to finally apply the set password.

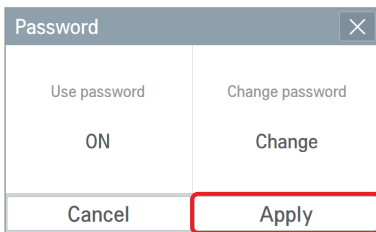

4) It displays that the password set-up is completed.

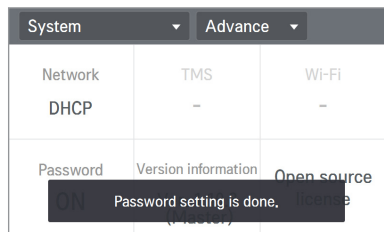

2. When you change the password

1) Select password change.

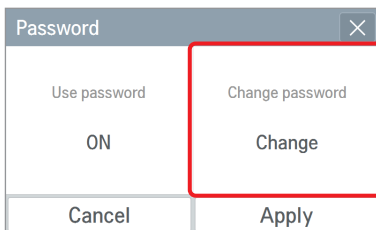

2) Input the current password and the new password, and press button.

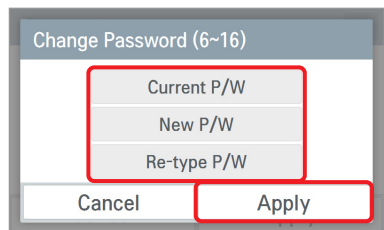

- 3) It displays that the password is set, and the password is displayed as used. You need to press button to apply the changed password.

Password	
Use password	Change password
ON	Change
Cancel	Apply

- 4) It displays that the password set-up is completed.

System	Advance	
Network	TMS	Wi-Fi
DHCP	-	-
Password	Version information	Open source
Password setting is done.		

3. If you do not use the password

- 1) Select password usage.

Password	
Use password	Change password
ON	Change
Cancel	Apply

- 2) It displays that the password is cleared, and the password is displayed as not used. You need to press button to apply password not used.

Password	
Use password	Change password
OFF	Change
Cancel	Apply

- 3) It displays that the password set-up is completed.

System	Advance	
Network	TMS	Wi-Fi
DHCP	-	-
Password	Version information	Open source
Password setting is done.		

4. In case of wrong password input,

1) In case of wrong password input, it displays the phrase saying that the password input is wrong as follows.

2) In case of 5 repeated wrong password input, it verifies whether to initialize the password.

When you press button, the password input screen appears again.

✳ For the password initialization, please contact the installation store or service center.

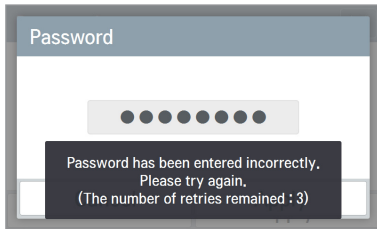

<In case of wrong password input>

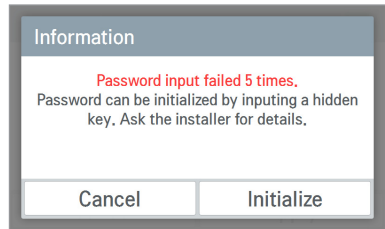

<In case of 5 repeated wrong password input>

<Version information & SW update>

In this screen, it displays the current version information of the controller.

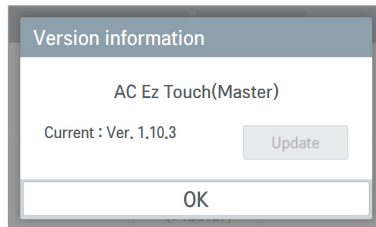

✳ Update function is an installer and service function.

<Open source license>

This screen displays an open source license notice of AC Ez Touch.

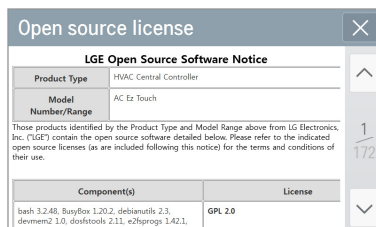

Screen setting

<Theme setting>

In this screen, you can select white / black theme according to the usage environment. Select the desired theme, and press button.

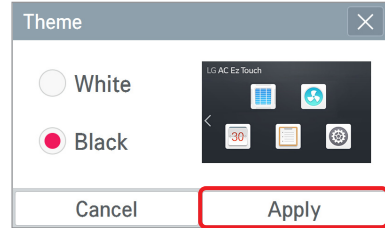
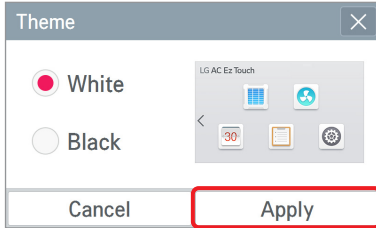

<Screen saver setting>

In this screen, it sets the screen saver to display on the screen.

Select whether to use screen saver / guide word button / screen saver preview button, and press button.

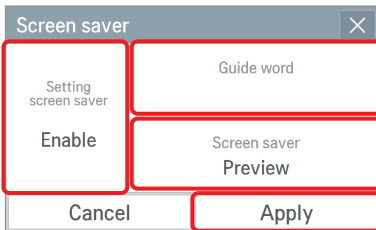

1) Screen saver setting

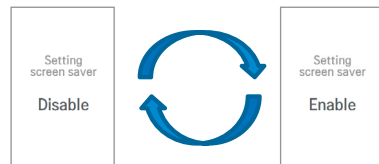

2) Screen saver guide edit

Input the phrase to display at the bottom of the screen saver, and press button.

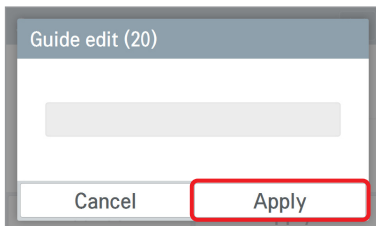

3) Screen saver preview

In this screen, you can preview the screen saver.

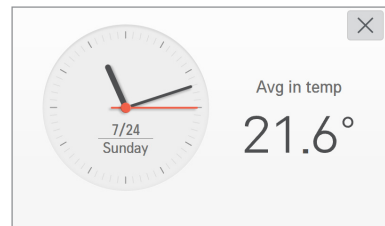

! NOTE

If the monitor power standby time is the same as the screen saver standby time or shorter, the monitor power is turned off.

<Screen saver waiting time setting>

It sets the standby time before displaying the screen saver when there is no input.

→ Screen saver standby time [1 minute / 5 minutes / 10 minutes]

Select the screen saver standby time, and press button.

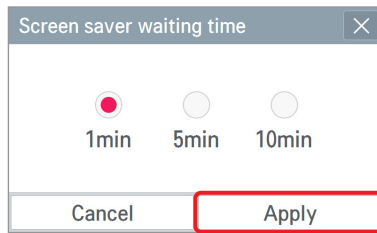
**<Monitor power waiting time setting>**

It sets the standby time before turning off the screen when there is no input.

→ Monitor power standby time [1 minute / 5 minutes / 10 minutes / OFF]

Select the monitor power standby time, and press button.

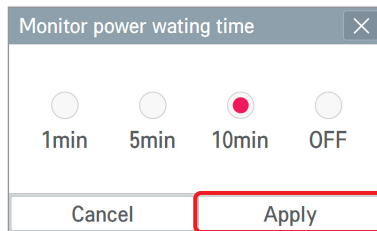

While the monitor power is turned off, when you touch the screen, it displays the screen again.

<Screen brightness setting>

In this screen, you can set the brightness of the screen according to the ambient illumination.

→ Screen brightness selection [25%, 50%, 75%, 100%]

Select the screen brightness, and press button.

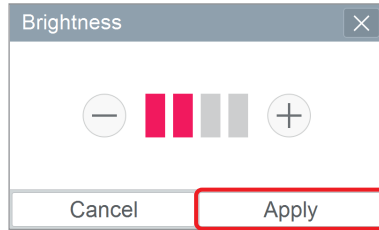

! NOTE

The screen brightness set-up function is not supported on the PC.

Installer setting

<LGAP setting>

In this screen, you can set Master / Slave according to the interface status to the central controller.

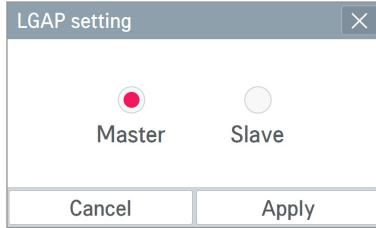

If the one AC Ez Touch is installed without other central controller, set to Master.

! NOTE

In slave state, you cannot use each equipment's lock setting, set temp range, 2set point, IDU 2set, auto search device function, energy report and energy save mode.

<Language update (for service)>

This screen is the function to update language when multi-language needs to be applied.

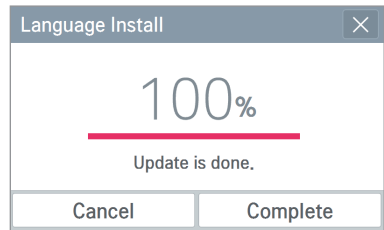
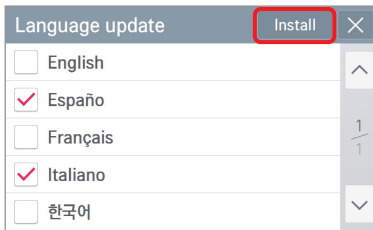

* Language update function is for service.

<Device management>

In this screen, you can search registered device and register the searched device to the device management list. At this time, device that can be searched is Air conditioner/Ventilation/Heating.

1. Auto registration function

- 1) To automatically search the connected device, press **Auto** button.
- 2) To run the auto device registration, check the following cautions, and then press **OK** button.

Device management					
Type	Name	Address	Model	Capa	
IDU	AC_00	00	AC	3	1 / 13
IDU	AC_01	01	AC	3	
IDU	AC_02	02	AC	3	
IDU	AC_03	03	AC	3	
IDU	AC_04	04	AC	3	

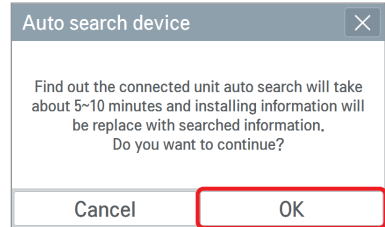

- 3) When the search is completed, it displays the number of searched indoor units. To register the searched device, press **Apply** button.

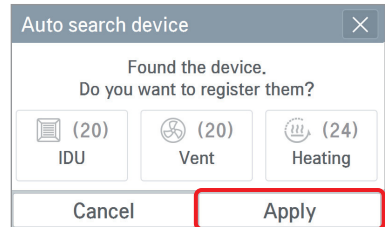
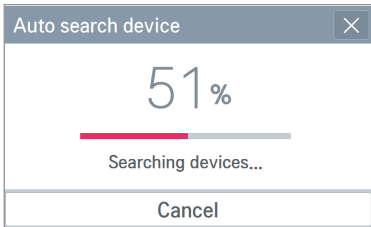

- 4) The searched device is added to the list. To complete the device registration, press **Complete** button.

Device management					
Type	Name	Address	Model	Capa	
IDU	AC_00	00	AC	3	1 / 13
IDU	AC_01	01	AC	3	
IDU	AC_02	02	AC	3	
IDU	AC_03	03	AC	3	
IDU	AC_04	04	AC	3	

! NOTE

In slave state, you cannot use each equipment's lock setting, set temp range, 2set point, IDU 2set, auto search device function, energy report and energy save mode.

- 5) It checks whether to lock the address of the indoor unit so that general user may not change the set indoor unit address without authorization. To set the indoor unit address lock, press button, and if you do not set, press button.

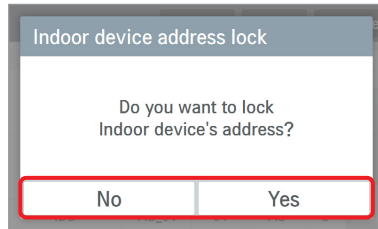

- 6) It displays the phrase saying that the device information is updated, and it displays the number of registered device.

Installer	
LGAP setting	Device management
Master	IDU 20
	ERV 12
Language update	ERV DX 8
	Indoor device information is updated. 4

2. Manual registration function

1) Press button at the top.

Device management						Auto	Edit	Complete
Type	Name	Address	Model	Capa				
IDU	AC_00	00	AC	3				
IDU	AC_01	01	AC	3				
IDU	AC_02	02	AC	3				
IDU	AC_03	03	AC	3				
IDU	AC_04	04	AC	3				

2) Press button at the top.

Device management						Add	Del	×
Type	Name	Address	Model	Capa				
<input type="checkbox"/>	IDU	AC_00	00	AC	3			
<input type="checkbox"/>	IDU	AC_01	01	AC	3			
<input type="checkbox"/>	IDU	AC_02	02	AC	3			
<input type="checkbox"/>	IDU	AC_03	03	AC	3			
<input type="checkbox"/>	IDU	AC_04	04	AC	3			

3) Input the detail information of the device to add.

(device type, device name, address, model, capacity)

4) Press button.

Add device			×
Device type	Name (20)	Address (2)	
-	No Input	No Input	
Model (20)	Capacity (5)	Batch add	
No Input	3	No Input	
<input type="button" value="Cancel"/>		<input type="button" value="Apply"/>	

5) It enters the device management screen.

6) To reflect the device addition, press

button.

Device management						Auto	Edit	Complete
Type	Name	Address	Model	Capa				
IDU	AC_0A	0A	AC	3				
IDU	AC_0B	0B	AC	3				
IDU	AC_0C	0C	AC	3				
IDU	AC_0D	0D	AC	3				
IDU	AC_0E	0E	AC	3				

7) It checks whether to lock the device address so that general user may not change the set device address without authorization.

To lock the device address, press

button, and when you do not set, press button.

Indoor device address lock
Do you want to lock Indoor device's address?
<input type="button" value="No"/> <input type="button" value="Yes"/>

8) It displays the phrase saying that the device information is updated, and it displays the number of registered device.

Installer		
LGAP setting	Device management	
Master	IDU	20
	ERV	12
Language update	ERV DX	8
	Indoor device information is updated.	
		4

3. Manual edit function

1) Select the device to edit in the device management list.

Device management					Auto	Edit	Complete
Type	Name	Address	Model	Capa			
IDU	AC_00	00	AC	3	1 13		
IDU	AC_01	01	AC	3			
IDU	AC_02	02	AC	3			
IDU	AC_03	03	AC	3			
IDU	AC_04	04	AC	3			

2) Press button in the detail device information screen.

Device detail ✕

Name	AC_00		
Type	IDU	Model	AC
Addr	00	Capa	3

Delete
Edit
OK

3) Input the detail information of the device to edit.
(device type, device name, address, model, capacity)

4) Press button.

Edit unit ✕

Device type	Name (20)	Address (2)
IDU	First Room	00
Model (20)	Capacity (5)	Batch add
AC	3	No Input

Cancel
Apply

5) It enters the device management screen.

6) To reflect the device edition, press button.

Device management					Auto	Edit	Complete
Type	Name	Address	Model	Capa			
IDU	First Ro...	00	AC	3	1 13		
IDU	AC_01	01	AC	3			
IDU	AC_02	02	AC	3			
IDU	AC_03	03	AC	3			
IDU	AC_04	04	AC	3			

7) It checks whether to lock the device address so that general user may not change the set device address without authorization.

To lock the device address, press button, and when you do not set, press button.

Indoor device address lock

Do you want to lock
Indoor device's address?

No
Yes

8) It displays the phrase saying that the device information is updated, and it displays the number of registered device.

Installer		
LGAP setting	Device management	
Master	IDU	20
	ERV	12
Language update	ERV DX	8
	Indoor device information is updated.	4

4. Device delete function

1) Press **Edit** button at the top.

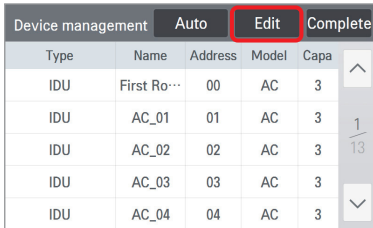

2) Select the device to delete.

3) Press **Del** button at the top.

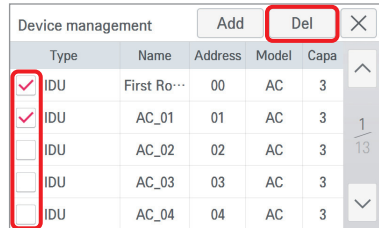

4) To proceed with the delete, press **Apply** button.

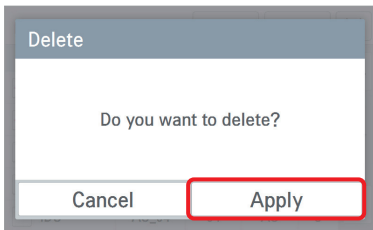

5) It enters the device management screen.

6) To reflect the device deletion, press **Complete** button.

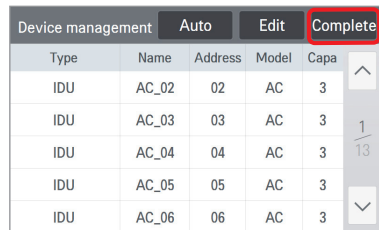

7) It checks whether to lock the device address so that general user may not change the set device address without authorization.

To lock the device address, press **Yes** button, and when you do not set, press **No** button.



8) It displays the phrase saying that the device information is updated, and it displays the number of registered device.

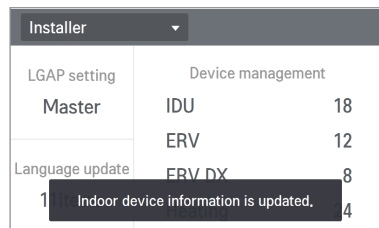

PC access

It supports the function that you can control and monitor connected devices via the web application.

1. Set the IP in the network setting screen.
2. Connect by entering the IP set in the web browser. Click the download link.

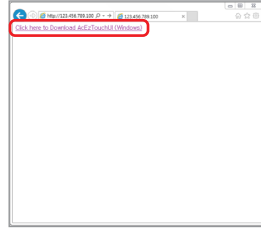
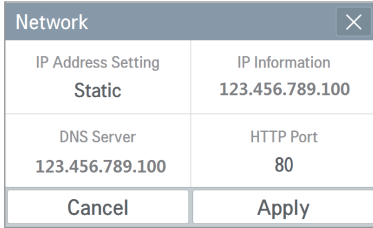

3. Install the program.

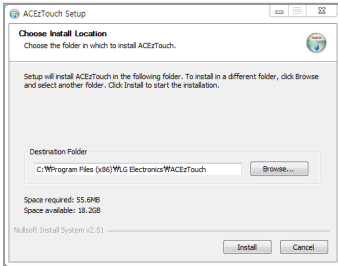

4. Run the installed program.



5. Enter the Name and IP.
Click on the "Setup" button.
(Enter the name after 'ACEzTouch_')

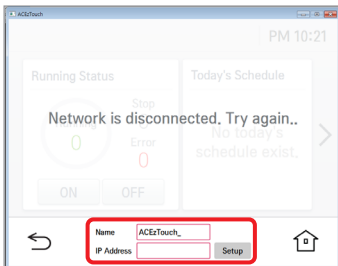

6. Connected.

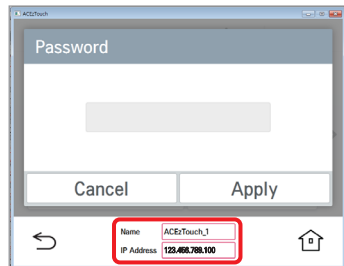

<Requirements>

Hardware	
CPU	Dual core 2.4GHz or more
Main memory	4GB or more
Hard disk	At least 1GB of free space on the disk
Main OS	Windows XP/7/8/8.1/10 (32/64bits)

Installation and setting

In this chapter, it describes the installation and setting method to set AC Ez Touch.

To use AC Ez Touch, you need to establish the environment for the controller and the equipment (Air conditioner/Ventilation/Heating) to communicate with each other, and you need to register the corresponding equipment through AC Ez Touch.

You need to install in the following order.

Step 1 : Installation environment check and setting up the equipment address

Before installing AC Ez Touch, check the network composition with the interfaced equipment, and assign address that does not overlap on the connected equipment.

Step 2 : Product installation and RS485 communication connection

Install AC Ez Touch and connect RS-485 communication cable.

Step 3 : Connecting cables and power adapter

Connect network and other cables, and then connect the power adapter.

Step 4 : Air conditioner/Ventilation/Heating equipment registration and group set-up

Register the connected air conditioner, ventilation and heating equipment, and set the group.

Step 5 : Operation

Check if basic control and the set up contents work normally.



CAUTION

- Installation work requires specialized technology. Therefore, the installation contents mentioned in this chapter must be carried out by a qualified installation technician.
- If you have questions or requests related to the installation, please contact the service center or specialist installation company acknowledged by LG Electronics.

Installation environment check and setting up the equipment address

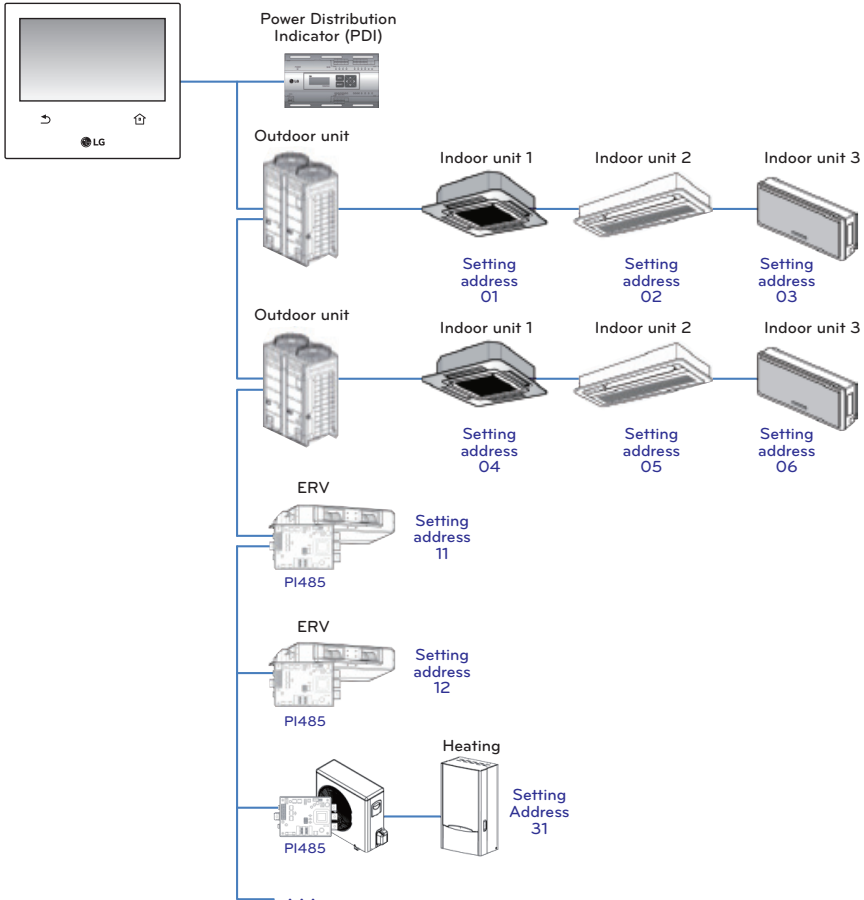

NOTE

- The maximum communication distance guaranteed by LG Electronics is 1 000 m. That is, the equipment installed at the farthest location from AC Ez Touch shall be within 1 000 m.
- It is recommended to use the communication cable of 0.75 mm² or more.
- Set a unique address, that does not overlap with other equipment on the same bus.
- Each device which can be used with PDI must be set to a unique address when connected with PDI. For further information about the devices can be used with PDI, please refer to the PDI manual.

<RS485 communication cable connection>

Maximum of 64 indoor units can be connected to one AC Ez Touch. If multiple number of the outdoor units need to be connected, the connection should be in BUS type. Otherwise, AC Ez Touch may malfunction.

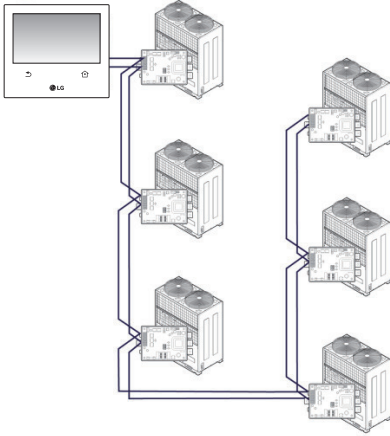

<Correct example :
RS485 BUS-type connection>

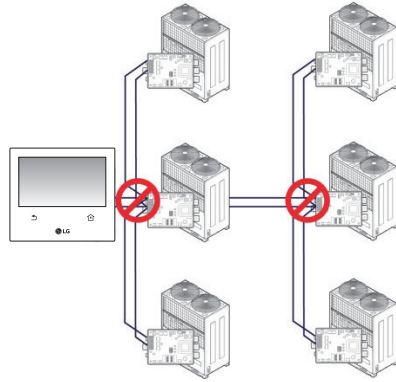

<Incorrect example :
RS485 STAR-type connection>

Central control address of the indoor unit set-up

First, you need to assign address that does not overlap with other equipment (Air-conditioner/Ventilation/Heating equipment) considering the entire installation composition connected to one AC Ez Touch.

The equipment address can be set in hexadecimal from 00 to FF.

! NOTE

Outdoor unit and indoor unit number assignment

If the outdoor unit product is Multi V, it is recommended to set the first digit of the address as the outdoor unit number, and set the second digit as the indoor unit number, so that the system composition and division can be easily identified during the address setting.

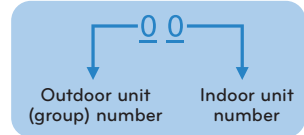

! NOTE

Indoor unit central control address setting

The central control address setting method may be different according to the indoor unit product or remote controller type, so set the address by referring to the indoor unit product or wired remote controller manual.

<Installing the product>

The installation and cable connection methods of AC Ez Touch are as follows.

1. Decide the space to install the controller.

- Before fixing the controller to the wall, check if it is a suitable location to connect the controller, RS485 cable, power cable, and ethernet cable.
- Determine the wiring direction of the product, and remove the knockout structure of the corresponding direction.

* Method of removing the knockout structure

- ① Cut the rim of the groove part on the both sides of the knockout structure using a nipper.

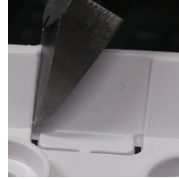

- ② After cutting, bend the knockout structure to the inward direction & outward director for 2 times, respectively.



- ③ Tear the knockout structure.

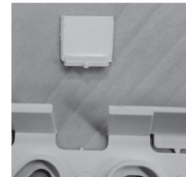

! NOTE

Make sure to use a nipper as tool. When using other tools such as pincers, a sharp cutting trail remains on the cut surface, and scratch or notches by the electric-wire may occur.



<when using a nipper>

<when using a pincers>

2. Fix the controller's wall installation plate to the wall above RS485 cable.

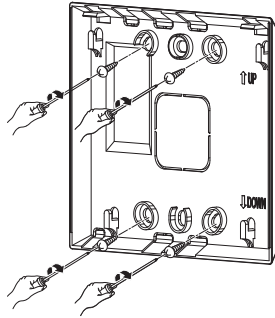

3. Connect RS485 cable located at the backside of the controller main unit to RS485 connector.

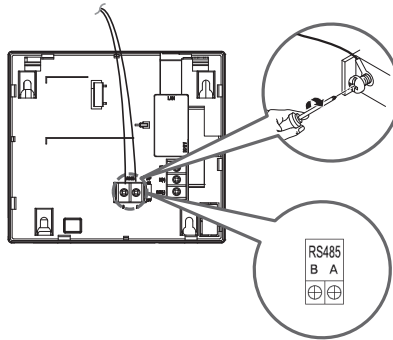

When connecting T/B, after removing the sheath referring to the guide as shown on the picture, make sure to connect by inserting a short-protecting sleeve into the O-ring or U-terminal.

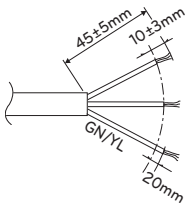

<Sheath-removal guide>

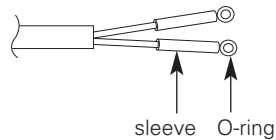

<Shape of applying to O-ring and sleeve>

CAUTION

- Be careful not to cross wire connections. RS485 communications are dependant on correct polarity.
- When the cable is connected in reclamation structure, be careful of the bending of RS485 communication cable.

4. If network connection is required from the controller, connect the ethernet cable to LAN port at the backside of the controller main unit.

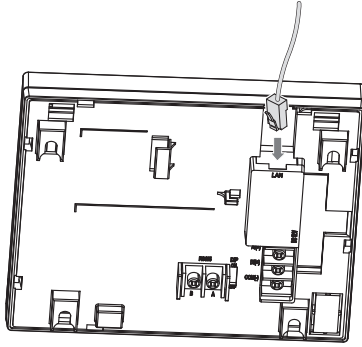

5. Connect power adaptor to the power connector located at the backside of the controller main unit.

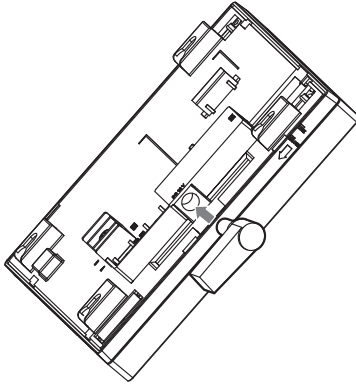

6. After matching the hook of the wall mounting plate installed on the wall and the groove of the product, push the product to match the groove.

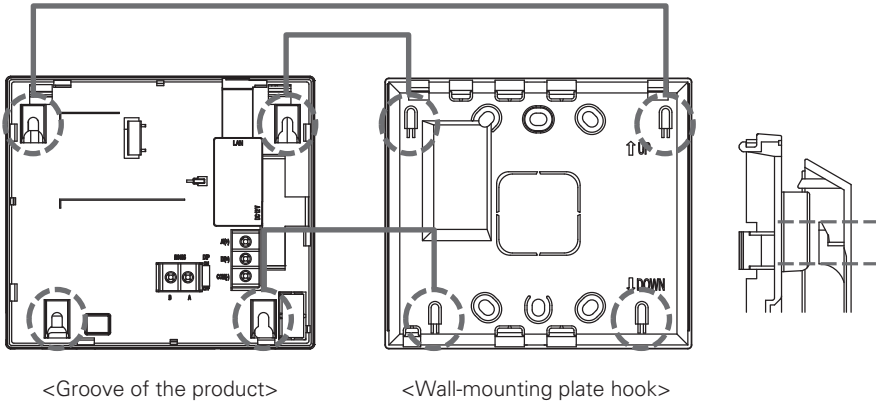

7. Push down the product to lock the top hook.

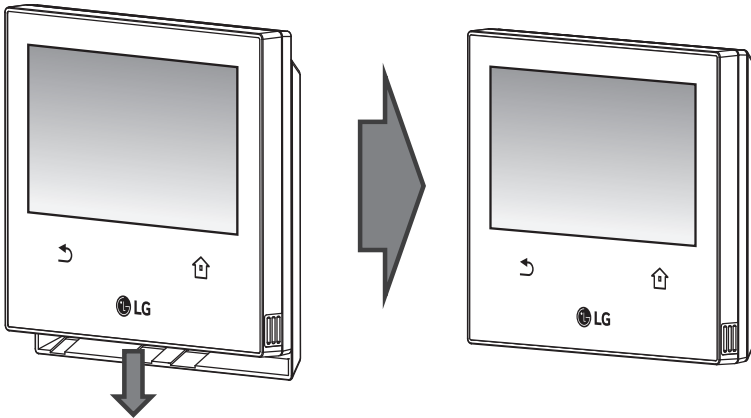

! NOTE

Separation sequence is in reverse of installation sequence.

8. Connect the power cord of the power adapter of the power plug.

<Emergency stop function set-up>

AC Ez Touch has an emergency stop function to stop all connected equipment (Air-conditioner/Ventilation/Heating equipment) when there is an emergency in the building. When DI port detects a short circuit signal, AC Ez Touch stops the operations of all connected equipment.

Regarding emergency stop function, it can be used by connecting to the DI port of external powerless contact type on the rear of AC Ez Touch as shown below.

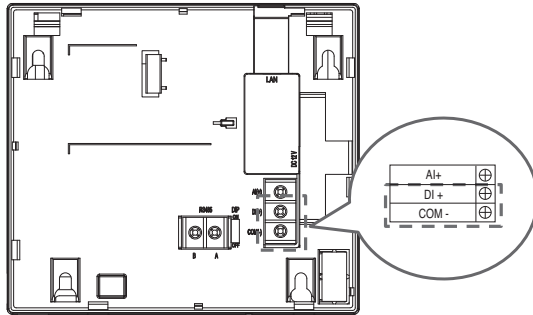

! NOTE

DI port shall always be in open state except the emergency situation.

Check list before calling for service

When any malfunction occurs to the product, check the following list before contacting the service center.

Symptoms	Check	Action
All products keep turning off.	Is the DI port in 'short' status?	Change DI port state to open state. (If DI port is in short circuit state, operations of all connected equipment stop.)
Product is reset in the middle of a night.	It is automatically reset at AM 2:05 every Monday.	
Equipment is not controlled.	Is the equipment in 'locked' status?	Check if lock function is set, and clear the lock function.
Error display appears on the equipment icon.	Is the equipments with the error message connected properly?	If the equipment are not properly connected, error is displayed. Check the equipment connection status.
Lock cannot be set. Cannot use temperature limit setting. Cannot user auto search device function.	Is the product set up as 'Slave' status?	In slave state, you cannot use each equipment's lock setting, set temp range, 2set point, IDU 2set, auto search device function, energy report and energy save mode.
PC program is stop.	-	After exiting the running program, try again.
Time is changed without setting manually.	Is daylight saving time set?	Please turn off daylight saving time.

Guide to open source software

If you want to obtain GPL, LGPL, MPL and other source codes developed under open source license, visit <http://opensource.lge.com>.

You can download all the contents of the relevant license including source code, copyright marking and marking which represents there is no guaranteed liability.

If you request open source code of the software installed in this product by sending e-mail to opensource@lge.com within 3 years from the purchase of the product, it will be provided in CD-ROM with minimum fee for media, transportation, etc.

